

ASTRO®

XTS™ 2500 & XTS™ 2500I

Model 2

User Guide



ASTRO® XTS™ 2500 / XTS™ 2500I

Digital Portable Radio, Model II

Quick Reference Card

Product Safety and RF Exposure Compliance



Before using this product, read the operating instructions for safe usage contained in the Product Safety and RF Exposure booklet enclosed with your radio.

ATTENTION!

This radio is restricted to occupational use only to satisfy FCC RF energy exposure requirements. Before using this product, read the RF energy awareness information and operating instructions in the Product Safety and RF Exposure booklet enclosed with your radio (Motorola Publication part number 6881095C98) to ensure compliance with RF energy exposure limits.

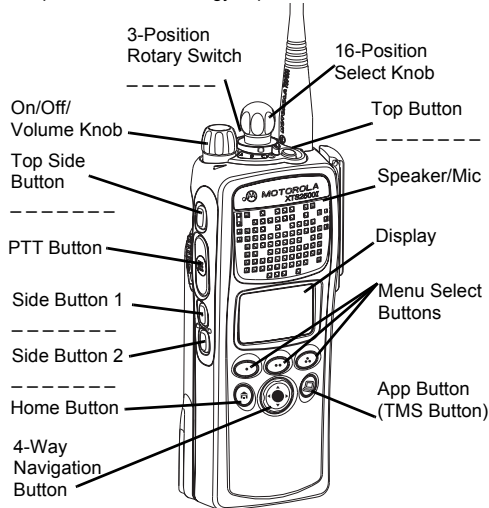

Write your radio's programmed features on the dotted lines.

Select a Zone Using the Menu

- 1 Press until ZONE
- 2 Press , , or directly below ZONE.
- 3 Press until the zone you desire is shown **OR** Use the **keypad** directly to dial the zone number.
- 4 Press to confirm, or press **PTT** to transmit.

Select a Channel

Method 1: Using the Select Knob

After selecting the desired zone, turn the 16-position Select Knob to the desired channel.

Method 2: Using the Menu

- 1 Press until CHAN
- 2 Press , , or directly below CHAN.
- 3 Press until channel you desire is shown.
- 4 Press to confirm, or press **PTT** to transmit.

Send an Emergency Alarm

- 1 Radio on and press **Emergency** button. You see red LED; you hear short, medium-pitched
- 2 Display shows EMERGENCY .

- 3 When acknowledgment is received, you hear four tones; alarm ends; radio exits emergency.

Send Silent Emergency Alarm

- 1 Radio on and press **Emergency** button. You see no LED; you hear no tone.
- 2 Press **PTT**.
- 3 Alarm continues until you exit by:
 - Press and hold **Emergency** button for one second**OR**
 - Press **PTT** again.











Answer a Phone Call



- 1 Phone-like ringing, LED blinks GREEN, PHONE CALL and are displayed
- 2 Press **Call Response** button.
- 3 Press **PTT** button to talk; release to listen
- 4 Press to hang up.

Send a Phone Call

- 1 Press until PHON
- 2 Press , , or directly below PHON .
- 3 Press or to scroll to phone number.
- 4 Press **PTT** (or **Quick Access** button, if programmed) to talk, release to listen.

Display Status Symbols

	Call Received. Receiving an individual call.
	View/Program Mode. The radio is in the view or program mode; On Steady = view mode; Blinking = program mode.
	Received Signal Strength Indication (RSSI). Received signal strength for the current site (trunking only). The more stripes in the symbol, the stronger the signal.
	Battery <ul style="list-style-type: none"> Conventional = Blinks when the battery is low. Smart = The number of bars (0 – 3) shown indicates the charge remaining in your battery. Note: Smart battery will be available at a future date.
	Talkaround. You are talking directly to another radio or through a repeater; On = direct; Off = repeater.
	Monitor (Carrier Squelch). This channel is being monitored.
	Scan. The radio is scanning a scan list.
	User Login Indicator (IP Packet Data) <ul style="list-style-type: none"> On = User is associated with the radio; Off = User is not associated with the radio; Blinking = Registration with the server failed.
	
	

	Location Signal <ul style="list-style-type: none"> Off = Location feature disabled, or insufficient battery power in location accessory device; Blinking = Location feature enabled, but no location signal available; On = Location feature enabled, and location signal available.
	

Menu Entries (Use With Menu Navigation)

Entry	Menu Selection	Page
BATT	Smart Battery*	17
CALL	Private Call	50
CHAN	Select a Channel	25
CLOCK	Edit Time and Date	65
DIR	Repeater/Direct	55
PAGE	Call Alert Page	53

Entry	Menu Selection	Page
PHON	Phone	46
RPGM	Reprogram Request	58
SCAN	Scan On/Off	42
SITE	Site Lock	62
TGRP	Talkgroup Call	54
TMS	Text Messaging	78
USER	User Login	73
VIEW	Viewing a List	41
ZONE	Select a Zone	23

*Available at a future date.

Menu Navigation

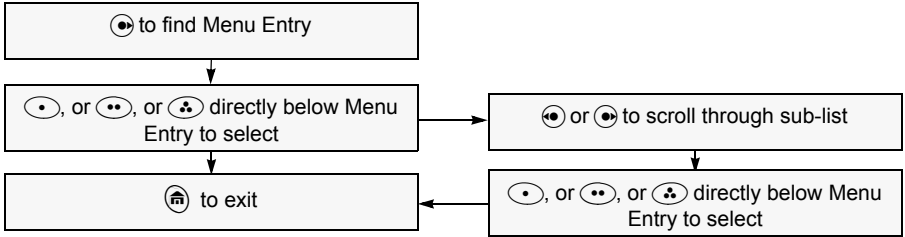

This declaration is applicable to your radio *only* if your radio is labeled with the FCC logo shown below.

Declaration of Conformity

Per FCC CFR 47 Part 2 Section 2.1077(a)



Responsible Party

Name: Motorola, Inc.

Address: 1301 E. Algonquin Rd, Schaumburg, IL 60196-1078 USA

Phone Number: 1-800-927-2744

Hereby declares that the product:

Model Name: **XTS 2500/XTS 2500I**

conforms to the following regulations:

FCC Part 15, subpart B, section 15.107(a), 15.107(d) and section 15.109(a)

Class B Digital Device

As a personal computer peripheral, this device complies with Part 15 of the FCC Rules. Operation is subject to the following two conditions:

1. This device may not cause harmful interference, and
2. This device must accept any interference received, including interference that may cause undesired operation.

Note: This equipment has been tested and found to comply with the limits for a Class B digital device, pursuant to part 15 of the FCC Rules. These limits are designed to provide reasonable protection against harmful interference in a residential installation. This equipment generates, uses and can radiate radio frequency energy and, if not installed and used in accordance with the instructions, may cause harmful interference to radio communications. However, there is no guarantee that interference will not occur in a particular installation.

If this equipment does cause harmful interference to radio or television reception, which can be determined by turning the equipment off and on, the user is encouraged to try to correct the interference by one or more of the following measures:

- Reorient or relocate the receiving antenna.
- Increase the separation between the equipment and receiver.
- Connect the equipment into an outlet on a circuit different from that to which the receiver is connected.
- Consult the dealer or an experienced radio/TV technician for help.

Product Safety and RF Exposure Compliance



Before using this product, read the operating instructions for safe usage contained in the Product Safety and RF Exposure booklet enclosed with your radio.

ATTENTION!

This radio is restricted to occupational use only to satisfy FCC RF energy exposure requirements. Before using this product, read the RF energy awareness information and operating instructions in the Product Safety and RF Exposure booklet enclosed with your radio (Motorola Publication part number 6881095C98) to ensure compliance with RF energy exposure limits.

For a list of Motorola-approved antennas, batteries, and other accessories, visit the following web site which lists approved accessories: <http://www.motorola.com/governmentandenterprise>

Computer Software Copyrights

The Motorola products described in this manual may include copyrighted Motorola computer programs stored in semiconductor memories or other media. Laws in the United States and other countries preserve for Motorola certain exclusive rights for copyrighted computer programs, including, but not limited to, the exclusive right to copy or reproduce in any form the copyrighted computer program. Accordingly, any copyrighted Motorola computer programs contained in the Motorola products described in this manual may not be copied, reproduced, modified, reverse-engineered, or distributed in any manner without the express written permission of Motorola. Furthermore, the purchase of Motorola products shall not be deemed to grant either directly or by implication, estoppel, or otherwise, any license under the copyrights, patents or patent applications of Motorola, except for the normal non-exclusive license to use that arises by operation of law in the sale of a product.

Documentation Copyrights

No duplication or distribution of this document or any portion thereof shall take place without the express written permission of Motorola. No part of this manual may be reproduced, distributed, or transmitted in any form or by any means, electronic or mechanical, for any purpose without the express written permission of Motorola.

Disclaimer

The information in this document is carefully examined, and is believed to be entirely reliable. However, no responsibility is assumed for inaccuracies. Furthermore, Motorola reserves the right to make changes to any products herein to improve readability, function, or design. Motorola does not assume any liability arising out of the applications or use of any product or circuit described herein; nor does it cover any license under its patent rights, nor the rights of others.

Notes

Contents

Declaration of Conformity	i
Product Safety and RF Exposure Compliance	ii
Computer Software Copyrights	ii
Documentation Copyrights	iii
Disclaimer	iii
General Radio Operation	1
Notations Used in This Manual	1
Additional Performance Enhancement	2
Dynamic System Resilience (DSR)	2
Encrypted Integrated Data (EID)	2
XTS 2500 / XTS 2500I Model II Radio	3
Physical Features of the XTS 2500 / XTS 2500I Model II Radio	4
Programmable Features	5
Display	6
Backlight	6
Status Symbols	7
Menu Entry (Softkey)	9
Menu Select Buttons	9
Menu Entry Features	10
Home Button (Ⓜ)	11
App Button (TMS Feature Button)	11
4-Way Navigation Button (Ⓜ)	11
LED Indicators	11
Alert Tones	12
Standard Accessories	15
Battery	15
Smart Battery Condition	17
Antenna	18
Belt Clip	19
Remove the Belt Clip	19
Universal Connector Cover	20
Remote Speaker Microphone Adapter	21
Radio On and Off	22
Turn the Radio On	22
Turn the Radio Off	22
Zones and Channels	23
Select a Zone	23
Select a Channel	25
Mode Select Button	27

Receive / Transmit	28
Without Using the Volume Set and Monitor Buttons	28
Use Preprogrammed Volume Set Button	29
Use the Preprogrammed Monitor Button	30
Conventional Mode Operation	31
Common Radio Features	32
Use the Menu	32
Using the Preprogrammed TX Power Level Switch	33
Conventional Squelch Options	34
Analog Squelch	34
Digital Squelch	34
PL Defeat	35
Time-out Timer	35
Emergency	36
Send an Emergency Alarm	36
Send an Emergency Call	37
Send a Silent Emergency Alarm	39
Emergency Keep-Alive	40
Lists	40
View a List	41
Scan List Empty	41
Scan	42
Turn Scan On and Off	42
Delete a Nuisance Channel	44
Conventional Scan Only	45
Telephone Calls (Trunking Only)	46
Answer a Phone Call	46
Phone Call Display and Alert Prompts	49
Private Calls (Trunking Only)	50
Answer a Private Call	50
Make a Private Call	51
Call Alert Paging	52
Answer a Call Alert Page	52
Make a Call Alert	53
Conventional Talkgroup Calls (Conventional Operation Only)	54
Select a Talkgroup	54
Repeater or Direct Operation	55
Select Repeater or Direct Operation	55

Special Radio Features.....	56
PTT ID	56
Receive	56
Transmit	56
View Your Radio's ID Number	57
Dynamic Regrouping (Trunking Only)	58
Reprogram Request (ASTRO 25 Trunking Only)	58
Select Enable / Disable	60
Trunking System Controls	61
Failsoft	61
Out-of-Range	61
Site Lock	62
Site Trunking	63
Site View and Change	63
Time and Date	65
Edit Time and Date	65
Outdoor Location (using GPS)	67
Access the Location Feature	67
Use the Menu	67
Location and Emergency Feature Interaction	69
GPS Enabled	69
IMPORTANT: Things to Keep in Mind	69
Enhancing GPS Performance	70
ARS User Login and Text Messaging Features.....	71
Automatic Registration Service (ARS)	71
Selecting or Changing ARS Mode	71
ARS User Login Feature	73
Accessing the User Login Feature	73
To Login as a User	74
Text Messaging	78
Accessing TMS Feature	78
Receive a Message	83
To View Message from the Inbox.	83
Send a Predefined Message	84
Reply to a Received Message	86
Delete a Message	87
To Access the Sent Folder	88

Helpful Tips	89
Radio Care	89
Cleaning	89
Handling	89
Service	89
Battery	90
Battery Life	90
Charging the Battery	90
Battery Recycling and Disposal	92
Antenna	93
Radio Operating Frequencies	93
 Accessories.....	 95
Antennas	95
Batteries	96
Carry Accessories	96
Belt Clips	96
Body-Worn	96
Chargers	97
Enhanced and Multi-Unit Line Cords	97
Microphones, Remote Speaker	98
Surveillance Accessories	99
Adapters and Adapter Cable	99
CommPort® Integrated Microphone/Receivers	99
Earpieces	99
Headsets and Headset Accessories	100
Radio Interface Modules for Ear Microphones	101
Switches	101
 Appendix: Maritime Radio Use in the VHF Frequency Range.....	 102
Special Channel Assignments	102
Emergency Channel	102
Non-Commercial Call Channel	103
Operating Frequency Requirements	103

Glossary	106
Commercial Warranty	111
Index	116

Table 1: Channel Map

Use the chart below to map the channels (Cx) and zones (Zx) for your radio.

	Z1	Z2	Z3	Z4	Z5	Z6
C1						
C2						
C3						
C4						
C5						
C6						
C7						
C8						
C9						
C10						
C11						
C12						
C13						
C14						
C15						
C16						

General Radio Operation

Notations Used in This Manual

You will notice the use of **WARNING**, **CAUTION**, and **Note** notations throughout this manual. These notations are used to emphasize that safety hazards exist and that care must be taken or observed.



WARNING

WARNING: An operational procedure, practice, condition, etc. exists which may result in injury or death if not carefully observed.





Caution

CAUTION: An operational procedure, practice, condition, etc. exists which may result in damage to the equipment if not carefully observed.

Note: A **Note** is an operational procedure, practice, or condition, etc. which is essential to emphasize.

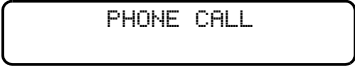
The following special notations identify certain items:

<i>Example</i>	<i>Description</i>
Light button, or 	Buttons and keys are shown in bold print, or as representative symbols.
	Information appearing in the radio's display is shown using the special display font.
PHONE	Menu entries are shown similar to the way they appear in the radio's display.
Press 	This means "Press the right side of the 4-Way Navigation Button ."

Additional Performance Enhancement

The following are some of the latest creations designed to enhance the security, quality and efficiency of your radio.

Dynamic System Resilience (DSR)

DSR ensures the radio system is seamlessly switched to a backup master site dynamically in case of system failure. DSR also provides additional indication e.g. failure detection, fault recovery, and redundancy within the system to address to the user in need. Mechanisms related to the Integrated Voice and Data (IV & D) or data centric are all supported by DSR.

Encrypted Integrated Data (EID)

EID provides security encryption and authentication of IV & D data bearer service communication between the radio and the Customer Enterprise Network.

XTS 2500 / XTS 2500I Model II Radio

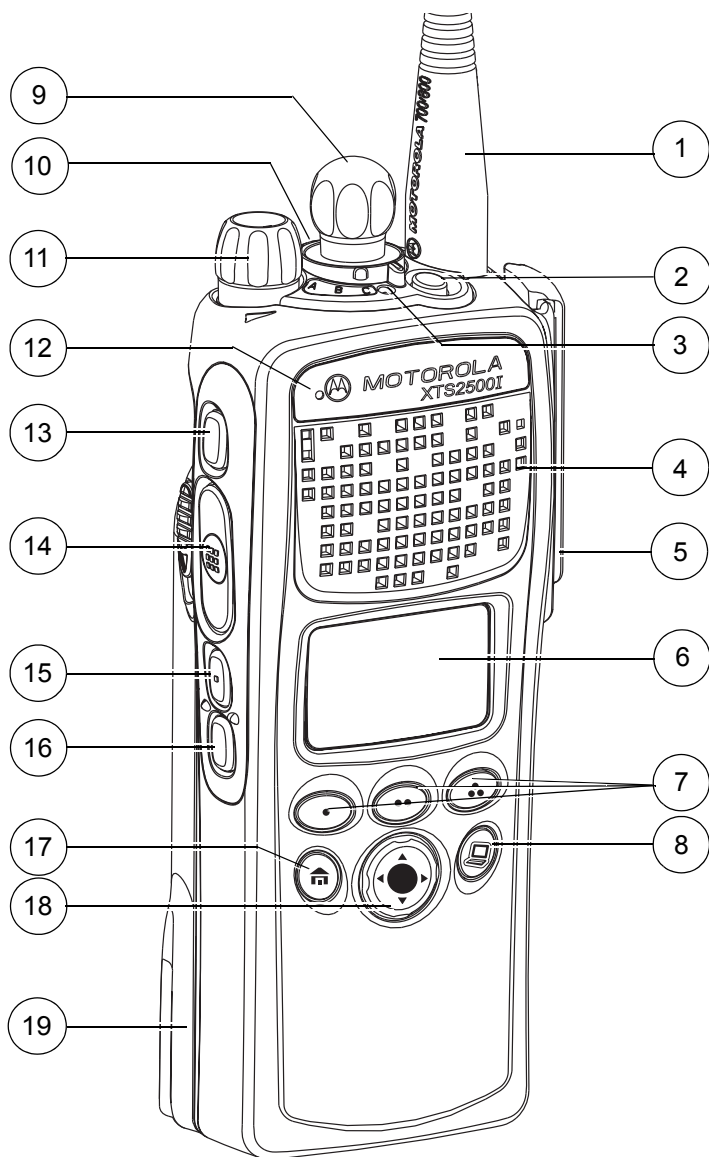

Physical Features of the XTS 2500 / XTS 2500I Model II Radio

<i>Item</i>	<i>Page</i>	<i>Item</i>	<i>Page</i>
1 Antenna	18	11 On/Off/Volume Control Knob	22
2 Top Button (programmable)	–	12 Microphone	–
3 LED	11	13 Top Side (Select) Button (programmable)	–
4 Speaker	–	14 Push-to-Talk (PTT) Button	–
5 Universal Connector	20	15 Side Button 1 (programmable)	–
6 Display	6	16 Side Button 2 (programmable)	–
7 Menu Select Buttons	9	17 Home button	11
8 App Button	11	18 4-Way Navigation Button	11
9 16-Position Knob (programmable)	–	19 Battery	15
10 3-Position Concentric Switch (programmable)	–	–	–

Programmable Features

The programmable controls on your radio can be programmed by a qualified technician to operate certain software-activated features. The features that can be assigned to these controls, and the page numbers where these features can be found, are listed below.

Table 1: Programmable Features

<i>Feature</i>	<i>Page</i>	<i>Feature</i>	<i>Page</i>
Call Alert Page	53	Repeater/Direct	55
Call Response	46	Reprogram Request	58
Channel Selection	25	Scan On/Off	42
Dynamic Priority	45	Site Lock/Unlock	62
Emergency	36	Site Search	62
Light	6	Smart Battery*	17
Monitor	30	Text Messaging	78
Nuisance Delete	44	TMS Quick Text	84
Phone	46	User Login	73
PL Defeat	35	Volume Set	29
Private Call	50	Zone Selection	23
Outdoor Location	67	—	—

*Will be available at a future date.

Any references in this manual to controls that are “preprogrammed” means that a qualified technician must use the radio’s programming software to assign a feature to a control.

Display

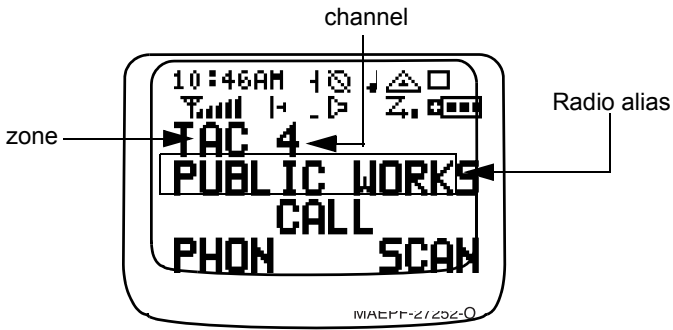

This figure is typical of what you see on your radio. The 64 x 96 pixel liquid crystal display (LCD) shows radio status, text, and menu entries.

Backlight

If poor light conditions make the display difficult to read, turn on the radio's backlight by pressing the **Light** button.

The light will remain on for a preprogrammed time before it turns off automatically, or you can turn it off immediately by pressing the **Light** button again.

Status Symbols

The top two rows in the display contain symbols indicating the radio's status.

Table 2: Status Symbols













Symbol	Indication	Page
	Call Received. Blinks when an Individual Call is received.	46
	View/Program Mode. <ul style="list-style-type: none"> • View a list (steady) • Program a list (blinking) 	41
	Received Signal Strength Indication (RSSI). The received signal strength for the current site. Trunked only. The more stripes in the symbol, the stronger the received signal.	63
	Battery <ul style="list-style-type: none"> • Conventional = Blinks when the battery is low. • Smart = The number of bars (0 – 3) shown indicates the charge remaining in your battery. Blinks when battery level reaches 10% or less. <p>Note: Smart battery will be available at a future date.</p>	15
	Talkaround. <ul style="list-style-type: none"> • On = Talking directly to another radio, not through a repeater. Conventional operation only. • Off = Talking through a repeater. 	55
	Monitor (Carrier Squelch). The selected channel is being monitored. Conventional operation only.	30

Table 2: Status Symbols (Continued)

Symbol	Indication	Page
	Scan. The radio is scanning a scan list.	42
  	User Login Indicator (IP Packet Data) <ul style="list-style-type: none"> • On (Tinted) = User is currently associated with the radio; • Off (Not tinted) = User is currently not associated with the radio; • Blinking = Device registration or user registration with the server failed due to an invalid username or pin. 	73
 	Location Signal <ul style="list-style-type: none"> • Off = Location feature disabled, or insufficient battery power in location accessory device; • Blinking = Location feature enabled, but no location signal available; • On = Location feature enabled, and location signal available 	67

Menu Entry (Softkey)

The bottom row of the display contains one to three menu entries (also known as softkeys). The menu entries allow you to select from one of several menus to access the radio's features. The menu entries are accessed using the **Menu Select** buttons.

Menu Select Buttons

The Menu Select buttons access the menu entries of features that have been activated by a qualified radio technician. Your radio may be programmed differently from the following example, but the display for selecting Scan on or off might look like this:

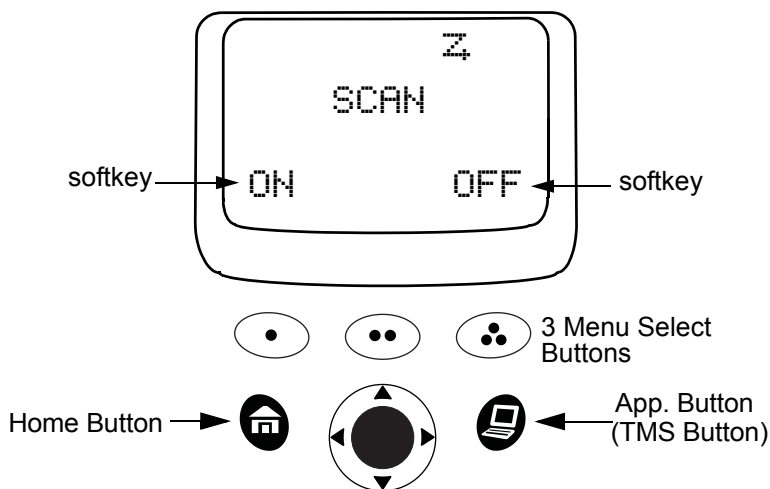

Example: To turn scan on:

Press .

The display shows the selected state.

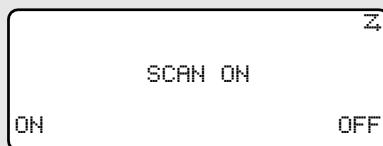

Menu Entry Features

In most cases, press  to display the following feature selections.

Table 3: Menu Entry Features

<i>Feature</i>	<i>Menu Selection</i>	<i>Page</i>
Call Alert Page	PAGE	53
Channel Selection	CHAN	25
Phone	PHON	46
Private Call	CALL	50
Repeater/Direct	DIR	55
Reprogram Request	RPGM	58
Scan On/Off	SCAN	42
Site Lock/Unlock	SITE	62
Site Search	SCANNING SITE	63
Smart Battery*	BATT	17
Talkgroup Call	TGRP	54
Time/Date	CLCK	65
Text Messaging	TMS	78
User Login	USER	73
View a List	VIEW	41
Zone Selection	ZONE	23

*Available at a future date.

Home Button (🏠)

The **Home** button will always return you to the home (default) display. In most cases, this is the current mode.

Some radio features require saving information in memory. Pressing the **Home** button while using those features will cause information to be saved before going to the home display.

Some features do not require you to press the **Home** button to go to the home display. This reduces the required number of button presses.

App Button (TMS Feature Button)

Reserved for future use.

4-Way Navigation Button (⬅️➡️)

This button is used to scroll through the radio's lists or items in the display.

LED Indicators

Table 4: LED Indicators

<i>This LED Color:</i>	<i>indicates:</i>
RED (Illuminated)	Transmitting
RED (Blinking)	<ul style="list-style-type: none"> • Channel Busy OR <ul style="list-style-type: none"> • Low Battery (lights while transmitting)
GREEN (Blinking)	Receiving Individual Call

Alert Tones

Your radio uses alert tones to inform you of radio conditions.

Table 5: Alert Tones

<i>You hear:</i>	<i>Tone Name</i>	<i>Heard:</i>
<i>Short, Low-Pitched Tone</i>	Invalid Button-Press	when the wrong key is pressed.
	Radio Self-Test Failed	when the radio fails the power-up self test.
	No ACK Received	when the radio does not receive an acknowledgment.
	Reject	when an unauthorized request is made.
	Time-Out Timer Warning	four seconds before time out.
<i>Long, Low-Pitched Tone</i>	Time-Out Timer Timed Out	after time out.
	Talk Prohibit/PTT Inhibit	when the PTT button is pressed, and transmissions are prevented.
	Out-of-Range	when the PTT button is pressed, but the radio is out of range of the system.
	Invalid Mode	when the radio is set to an unprogrammed channel.
	Individual Call Warning Tone	when the radio is in Individual Call without any activity for more than 6 seconds.
<i>A Group of Low-Pitched Tones (Busy Tone)</i>	Busy	when the system is busy.

Table 5: Alert Tones (Continued)

You hear:	Tone Name	Heard:
<i>Short, Medium- Pitched Tone</i>	Valid Key-Press	when the correct key is pressed.
	Radio Self-Test Pass	when the radio passes its power-up self-test.
	Priority Channel Received	when activity on a priority channel is received.
	Emergency Alarm Entry	when entering the emergency state.
	Central Echo	when the central controller has received a request from a radio.
<i>Long, Medium- Pitched Tone</i>	Volume Set	when volume changed on a quiet channel.
	Emergency Exit	upon exiting the emergency state.
<i>A Group of Medium- Pitched Tones</i>	Failsoft	when the trunking system fails.
	Automatic Call Back	when the voice channel is available from the previous request.
	Talk Permit	(When pressing the PTT button) verifies the system is accepting transmissions.
	Console Acknowledge	when a status, emergency alarm, or reprogram request acknowledgment is received.
	Received Individual Call	when a Call Alert, or Private Conversation Call is received.
	Call Alert Sent	when a Call Alert is received by the target radio.

Table 5: Alert Tones (Continued)

You hear:	Tone Name	Heard:
<i>A Group of Low-Pitched Tones followed by a group of High-Pitched Tones</i>	Scan Alert On	when the Scan feature is activated through the pre-programmed button or 3-Position Rotary Switch.
<i>A Group of High-Pitched Tones followed by a group of Low-Pitched Tones</i>	Scan Alert Off	when the Scan feature is deactivated through the pre-programmed button or 3-Position Rotary Switch.
<i>Short, High-Pitched Tone (Chirp)</i>	Low-Battery Chirp	when the battery is below the preset threshold value.
<i>Ringing</i>	Fast Ringing	when the system is searching for the Private Conversation Call target radio.
	Enhanced Call Sent	when waiting for the Private Conversation Call target radio to respond to the call.
	Phone Call Received	when a landline phone call is received.
<i>Gurgle</i>	Dynamic Regrouping	when the PTT button is pressed, a dynamic ID has been received.
<i>Unique, low-pitched chirp</i>	New Message	when a new message is received.
<i>Unique, high-pitched chirp</i>	Priority Message	when a priority message is received.

Standard Accessories

Battery



To avoid a possible explosion:

- **DO NOT** replace the battery in any area labeled “hazardous atmosphere”.
- **DO NOT** discard batteries in a fire.

Charge the Battery

The Motorola approved battery shipped with your radio is uncharged. Prior to using a new battery, charge it for a minimum of 16 hours to ensure optimum capacity and performance.

For a list of Motorola-authorized batteries available for use with your XTS 2500 / XTS 2500I radio, see “Batteries” on page 96.

Note: When charging a battery attached to a radio, turn the radio off to ensure a full charge.

Battery Charger

To charge the battery, place the battery, with or without the radio, in a Motorola-approved charger. The charger’s LED indicates the charging progress; see your charger’s user guide. For a list of chargers, see “Chargers” on page 97.

Attach the Battery

- 1 With the radio off, fit the three extensions at the bottom of the battery into the bottom slots on the radio.

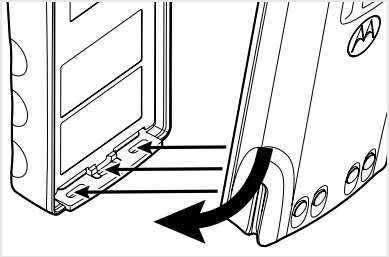

- 2 Press the top of the battery against the radio until both latches click into place.

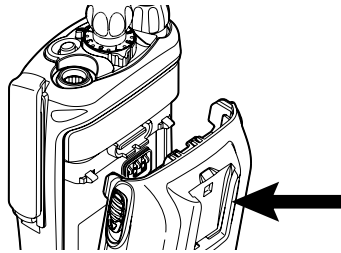

Remove the Battery

- 1 With the radio off, slide down the latches on the sides of the battery.

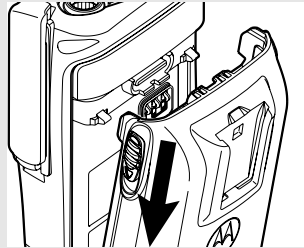

- 2 Pull the top of the battery away from the radio.

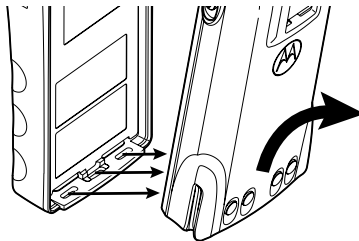



Smart Battery Condition

This feature allows you to view the condition of your Smart Battery.

Use the Menu

- 1 Press  to find BATT.

BATT

- 2 Press , , or  directly below BATT.

CAPACITY	70%
INIT	10/01
EST CHGS	11

Note: If a Smart Battery is not powering your radio:

SMART BATT
DATA NOT
AVAILABLE

- 3 Press  to exit.

Use the Preprogrammed Smart Battery Button

- 1 Press the **Smart Battery** button.

CAPACITY	70%
INIT	10/01
EST CHGS	11

Note: If a Smart Battery is not powering your radio:

SMART BATT
DATA NOT
AVAILABLE

- 2 Press  to exit.

Antenna

For information regarding other available antennas, see page 95.

Attach the Antenna

With the radio off, turn the antenna clockwise to attach it.

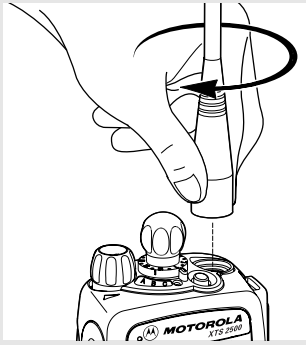

Remove the Antenna

With the radio off, turn the antenna counter-clockwise to remove it.

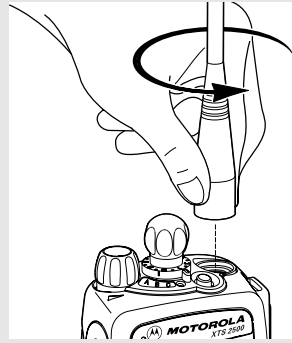

Belt Clip

Attach the Belt Clip

- 1 Align the grooves of the belt clip with those of the battery.

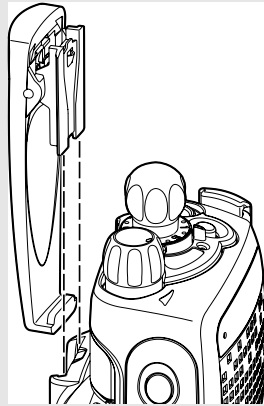

- 2 Press the belt clip downward until you hear a “click.”
-

Remove the Belt Clip

- 1 Use a flat-bladed object to press the belt clip tab away from the battery.

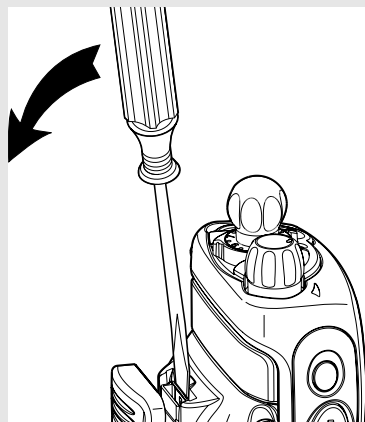

- 2 Slide the belt clip upward to remove it.
-

Universal Connector Cover

The universal connector cover is located on the antenna side of the radio. It is used to connect certain accessories to the radio.

Note: To prevent damage to the connector, shield it with the connector cover when not in use.

Remove the Connector Cover

- 1 Insert a flat-bladed screwdriver into the area between the bottom of the cover and the slot below the connector.
- 2 Hold the top of the cover with your thumb while you pry the bottom of the cover away from the radio with the screwdriver.

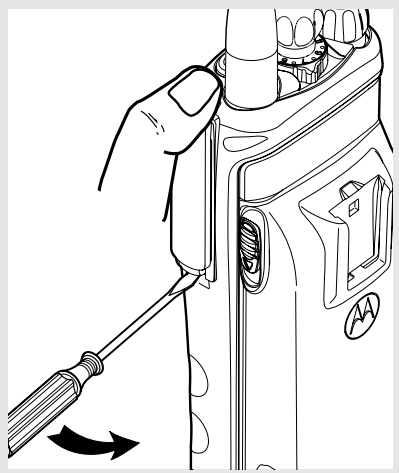

Attach the Connector Cover

- 1 Insert the hooked end of the cover into the top of the connector. Press downward on the cover's top to seat it into the slot.
- 2 Press the cover's lower tab below the connector until it snaps in place.

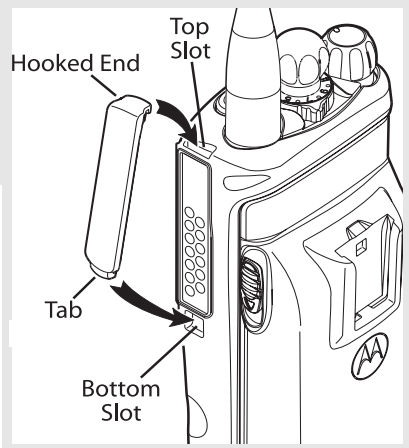

Remote Speaker Microphone Adapter

The Remote Speaker Microphone (RSM) adapter is located on the back of the radio, just above the battery. **It must be used to connect the RSM accessories to the radio.** If the RSM is not used, the adapter should be removed.

Remove the Adapter

Lift the larger side (below the antenna port) of the adapter away from the radio using your finger.

If you cannot easily remove the adapter with your finger, use a small, flat bladed screwdriver to pry the larger end side of the adapter away from the radio.

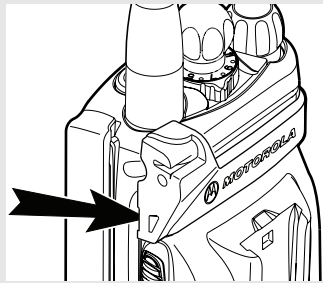

Attach the Adapter

- 1 With the Motorola side of the adapter facing out, snap the smaller end of the adapter into place in the shroud indent, below the **On/Off Volume Control Knob**.

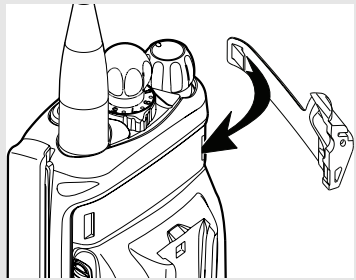

- 2 Snap the larger end of the adapter into place in the shroud indent, below the antenna port.

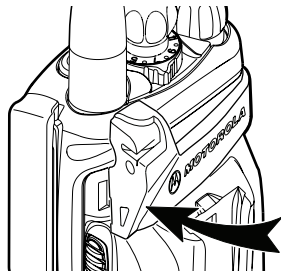

Radio On and Off

Turn the Radio On

Turn the **On/Off/Volume Control knob** clockwise.

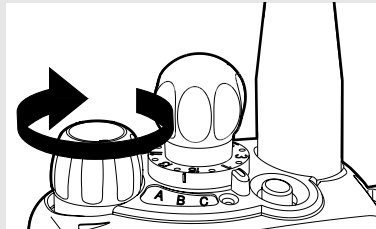

- If the power-up test is successful, you will briefly see **Self Test** and then the home display.
- If the power-up test is unsuccessful, you will see **ERROR XX/YY**. (XX/YY is an alphanumeric code.) Turn off the radio, check the battery, and turn the radio on again. If the radio continues to fail the power-up test, record the **ERROR XX/YY** code and contact a qualified service technician.

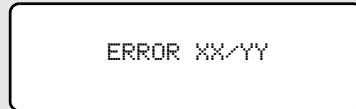
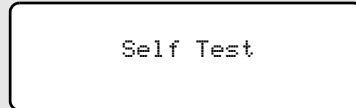

Turn the Radio Off

Turn the **On/Off/Volume Control knob** counterclockwise until it clicks.

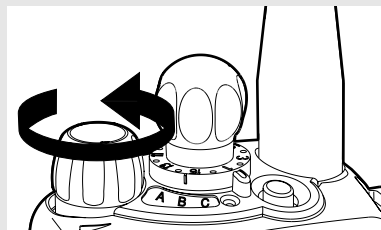

Zones and Channels

A zone is a grouping of channels. A channel is a group of radio characteristics, such as transmit/receive frequency pairs.

Before you use your radio to receive or send messages, you should select the zone and channel.



Select a Zone

Use the Menu Entry ZONE

- 1 Press  to find ZONE.



ZONE

- 2 Press , , or  directly below ZONE.
The current zone (in this case, POL) blinks and the channel name (DISP NW), does not flash.



POL DISP NW

- 3 Press  to find the zone you want. For example, FIRE.

OR

Use the keypad directly to dial the zone number.



FIRE DISP NW

- 4 Press  to confirm the displayed zone and channel.

OR

Press the **PTT** button to transmit on the displayed zone/channel.





FIRE DISP NW



Use the Menu Entry ZNUP or ZNDN

- 1 Press  to find ZNUP and ZNDN.



- 2 Press and hold , , or  directly below ZNUP or ZNDN until the zone you want appears.



Note: Positions of ZNUP and ZNDN on the display may differ each time you release , , or . Read carefully before you press.

Use the Preprogrammed Zone Switch

- 1 If a control on your radio has been preprogrammed as the **Zone** Switch, move the **Zone** Switch to the position for the zone you want.

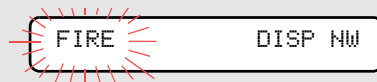

Note: If the zone you selected is unprogrammed, repeat this step.



- 2 Press  to confirm the displayed zone and channel.

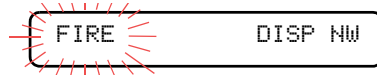

Select a Channel

Consult an authorized service technician for the right choice between the following methods.

Use the Preprogrammed Channel Selector

After the zone you want is displayed, turn the preprogrammed **Channel Selector** switch to the desired channel.



Use the Menu Entry CHAN

- 1 Press to find CHAN.



- 2 Press , , or directly below CHAN.

The display shows the current channel name (in this case, DISP NW) blinking and the zone (POL), not blinking.



- 3 Press to find the channel name you want.

Note: If the channel you selected is unprogrammed, repeat step 3.

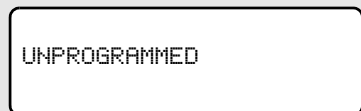

- 4 Press  to confirm the displayed zone and channel.

OR

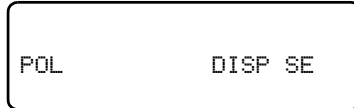

press the **PTT** button to transmit on the displayed zone/channel.







Use the Menu Entry CHUP or CHDN

- 1 Press  to find CHUP and CHDN.

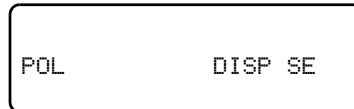

- 2 Press and hold , , or  directly below CHUP or CHDN until the channel name you want appears.



Note: Positions of CHUP and CHDN on the display may differ each time you release , , or . Read carefully before you press.

- 3 Press the **PTT** button to transmit on the displayed zone and channel.
-

Mode Select Button

This feature lets you program the current zone and channel to a **Mode Select** button with a long press on the **Mode Select** button. After the buttons are programmed, you can return to the pre-programmed zone and channel with a short press on the programmed **Mode Select** button.

The buttons that are assigned for this feature are labeled in the following picture.

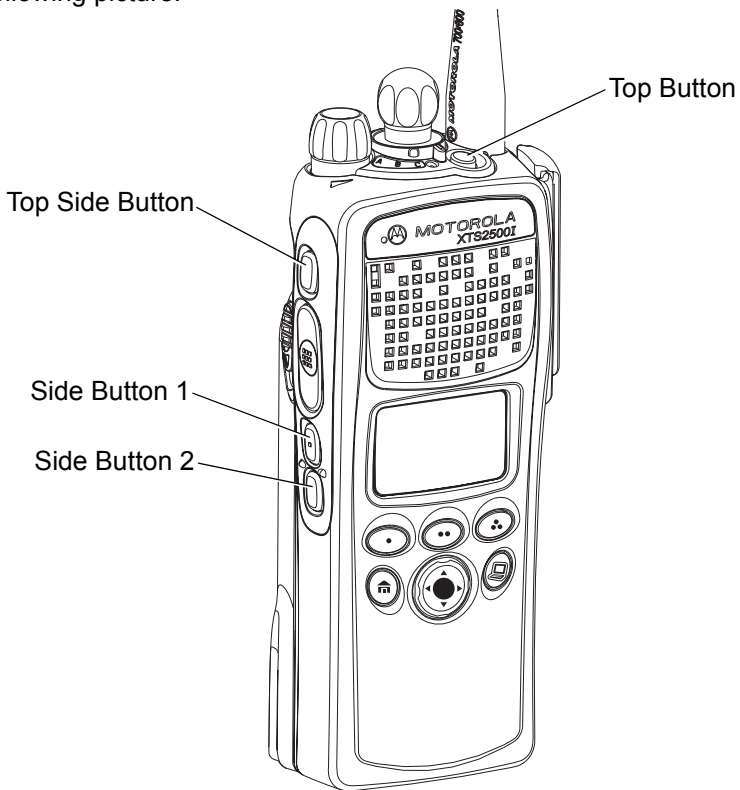

Receive / Transmit

Radio users who switch from analog to digital radios often assume that the lack of static on a digital channel is an indication that the radio is not working properly. This is not the case. Digital technology quiets the transmission by removing the “noise” from the signal and allowing only the clear voice or data information to be heard.

This section emphasizes the importance of knowing how to monitor a channel for traffic before keying-up to send a transmission.

Without Using the Volume Set and Monitor Buttons

- 1 Turn the radio on and select the desired zone and channel.
- 2 Listen for a transmission.
- 3 Adjust the **Volume Control** knob if necessary.

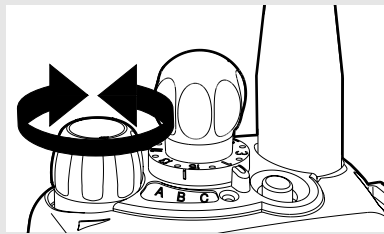

- 4 Press and hold the **PTT** button to transmit. The LED lights RED while transmitting.
- 5 Release the **PTT** button to receive (listen).

Use Preprogrammed Volume Set Button

- 1 Turn the radio on and select the desired zone and channel. See **Turn the Radio On**, page 22, and **Zones and Channels**, page 23.
- 2 Press and hold the **Volume Set** button to hear the volume set tone.
- 3 Release the **Volume Set** button.
- 4 Adjust the **Volume Control** Knob if necessary.

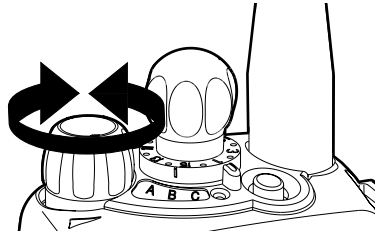

- 5 Press and hold the **PTT** button to transmit. LED lights RED while transmitting.
- 6 Release **PTT** button to receive (listen).

Use the Preprogrammed Monitor Button

- 1 Turn the radio on and select the desired zone and channel.
- 2 Press the Monitor button and listen for activity. (See the following **Conventional Mode Operation.**)



- 3 Adjust the **Volume Control** Knob if necessary.

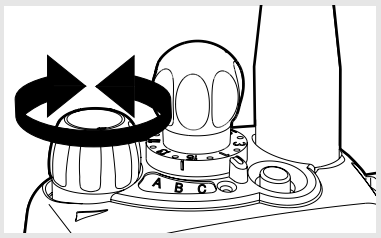

- 4 Press and hold the **PTT** button to transmit. The LED lights RED while transmitting.
- 5 Release the **PTT** button to receive (listen).

Conventional Mode Operation

Your radio may be programmed to receive Private-Line® (PL) calls.

- 1 Momentarily press the **Monitor** button to listen for activity. The Carrier Squelch indicator is displayed.



- 2 Press and hold the **Monitor** button to set continuous monitor operation. (The duration of the button press is programmable.)

- 3 Press the **Monitor** button again, or the **PTT** button, to return to the original squelch setting.

Note: If you try to transmit on a receive-only channel, you will hear an invalid tone until you release the **PTT** button.

Common Radio Features

Selectable Power Level

This feature lets you select the power level at which your radio will transmit. The radio will always turn on to the preprogrammed default setting.



- Select LOW for a shorter transmitting distance and to conserve power.
- Select HIGH for a longer transmitting distance.

Use the Menu

- 1 Press  to find PWR.



PWR

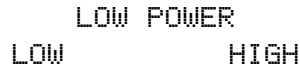

- 2 Press , , or  directly below PWR. The display shows the current power level (LOW or HIGH).

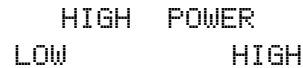

LOW POWER
LOW HIGH



HIGH POWER
LOW HIGH

- 3** Press , , or  directly below the desired power level (LOW or HIGH).
- The new transmit power level is saved.
 - The radio returns to the Home display.

- The new transmit power level is saved.
- The radio returns to the Home display.

Note: To exit at anytime, press  or the PTT button. The default setting returns when you turn the radio off and on.

Using the Preprogrammed TX Power Level Switch

- 1** Rotate the TX Power Level switch. The power level is set to low..



- 2** Rotate the TX Power Level switch again. The power level is set to high.



Conventional Squelch Options

Analog Squelch

Tone Private Line (PL), Digital Private-Line (DPL), and carrier squelch can be available (preprogrammed) per channel.

When in...	this condition occurs:
Carrier squelch (L ³)	You hear all traffic on a channel.
PL, DPL	The radio responds only to your messages.

Digital Squelch

One or more of the following options may be programmed in your radio. Consult your service technician for more information.

This option...	will allow you to hear:
Digital Carrier-Operated Squelch (COS)	any digital traffic.
Normal Squelch	any digital traffic having the correct Network access code.
Selective Switch	any digital traffic having the correct Network access code and correct talkgroup.

PL Defeat

With this feature, you can override any coded squelch (DPL, PL, or network ID) that might be programmed to a channel.

Place the preprogrammed **PL Defeat** switch in the **PL Defeat** position. You can now hear any activity on the channel. The radio is muted if no activity is present.

When this feature is active, the Carrier Squelch status indicator (CS) will be displayed.



Time-out Timer

The time-out timer turns off your radio's transmitter. The timer is set for 60 seconds at the factory, but it can be programmed from 0 to 7.75 minutes (465 seconds) by a qualified radio technician.

- | | |
|---|---|
| <p>1 Hold down the PTT longer than the programmed time. You will hear a short, low-pitched warning tone, the transmission is cut-off, and the LED will go out until you release the PTT.</p> | <ul style="list-style-type: none"> • Short warning tone • Transmission is cut-off • LED goes out |
| <p>2 Release the PTT button.</p> | <ul style="list-style-type: none"> • LED re-lights • Timer resets |
| <p>3 Press the PTT to re-transmit. Time-out timer restarts.</p> | <ul style="list-style-type: none"> • Timer restarts • RED LED |

Emergency

If the top (orange) button is programmed to send an emergency signal, then this signal overrides any other communications over the selected channel.

Your radio can be programmed for the following:

- Emergency Alarm
- Emergency Alarm with Emergency Call, or
- Silent Emergency Alarm
- Emergency Call.

Consult a qualified radio technician for emergency programming of your radio.

Send an Emergency Alarm

An Emergency Alarm will send a data transmission to the dispatcher, identifying the radio sending the emergency.

- 1 With your radio turned on, press the **Emergency** button. The current zone/channel is displayed alternately with **EMERGENCY**, the LED lights **RED**, and a short, medium-pitched tone sounds.



EMERGENCY

- RED LED
- Short Tone

If the selected channel does not support emergency, the display shows **NO EMERGENCY**. Select a channel that does show **EMERGENCY**.



NO EMERGENCY

Note: To exit emergency at any time, press and hold the Emergency button for about a second.

2 When you receive the dispatcher's acknowledgment, you see **ACK RECEIVED**, four tones sound, the alarm ends, and the radio exits the emergency mode.

ACK RECEIVED

- Four tones
- Alarm ends
- Radio exits emergency

If no acknowledgement is received, you see **NO ACKNOWLEDG**, the alarm ends, and the radio exits the emergency mode.

NO ACKNOWLEDG

Note: For Emergency Alarm with Emergency Call: The radio enters the Emergency Call state either after it receives the dispatcher's acknowledgment, or if you press the **PTT** button while in Emergency Alarm. Go to step 2 below: "Send an Emergency Call."

Send an Emergency Call

An Emergency Call will send a type of dispatch giving your radio priority access to channels.

The radio operates in the normal dispatch manner while in Emergency Call, except, if enabled, it will return to one of the following:

Using this operation:	means you will talk...
1. Tactical/Non-Revert	on the channel you selected before you entered the emergency state.
2. Non-Tactical/Revert	on a preprogrammed emergency channel. The emergency alarm is sent to this same channel.

- 1 With your radio turned on, press the **Emergency** button. The current zone/channel is displayed alternately with **EMERGENCY**, and a short, medium-pitched tone sounds.

EMERGENCY

- Short tone

Note: To exit emergency at any time, press and hold the **Emergency** button for about a second.

- 2 Press and hold the **PTT** button and announce the emergency into the microphone to send the Emergency call.
 - 3 Release the **PTT** button to end the call.
 - 4 Exit the Emergency State by pressing the **Emergency** button again for about one second (the time may be changed by a qualified technician). The radio returns to normal operation.
-

Send a Silent Emergency Alarm

- 1 With your radio turned on, press the **Emergency** button if your radio is programmed for this use.
 - Display does not change
 - LED does not light
 - No tones

The display does not change, the LED does not light, and no tones sound.

Note: To exit emergency at any time, press and hold the **Emergency** button for about a second.

- 2 The silent emergency state continues until you press and hold the **Emergency** button for about a second to exit the emergency state.
 - Press and hold the **Emergency** button

OR

Press and release the **PTT** button to exit silent emergency. The silent alarm is cancelled without an exit tone, and you can begin transmitting voice calls.

OR

- Press and release the **PTT** button

- Note:**
- For ALL Emergency signals: You can change channels while in Emergency operation if the new channel is also programmed for Emergency. The emergency alarm or call continues on the new channel.
 - If the new channel is NOT programmed for Emergency, you see **NO EMERGENCY**, and hear an invalid tone until you exit the Emergency state or change to a channel programmed for emergency.

Emergency Keep-Alive

If the radio is in the Emergency state, with Emergency Keep-Alive enabled, you cannot turn off the radio by using the **On/Off Control** knob.

With Keep-Alive, the radio will only exit the Emergency state using one of the ways mentioned in the previous sections (Emergency Alarm, Silent Emergency Alarm, or Emergency Call).

Lists

You can use lists to store frequently used numbers and associate them with names.



There are four list types:



- Call
- Page
- Phone
- Scan

View a List



- 1 Press  to find VIEW.

VIEW

- 2 Press , , or  directly below VIEW.



- 3 Press  or  to see the names of the available lists.

PAGE CALL PHON

- 4 Press , , or  directly below the desired list to view it.

The first list member is displayed. indicates the view mode.

FIRE CHIEF
701234

- 5 Press  or  to view other list members.

- 6 Press  to exit.

Scan List Empty

If the scan list has no members, EMPTY LIST is displayed.

EMPTY LIST

EMPTY LIST can be changed by turning scan off, or a qualified technician adds members to the scan list.

Scan

The scan feature allows you to monitor traffic on different channels by scanning a preprogrammed list of channels. Your radio can have up to 20 different scan lists. These lists must be preprogrammed by a qualified technician.



You can view the scan list assigned to the currently selected channel the same way you would view other lists. See “View a List” on page 41.

Turn Scan On and Off

Using the Menu





- 1 Press  to find SCAN.

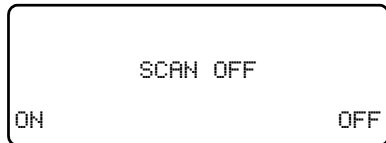

- 2 Press , , or  directly below SCAN.

The current scan state is displayed.



- 3 Press , , or  directly below ON or OFF. When scan is on, the scan status symbol () is displayed.

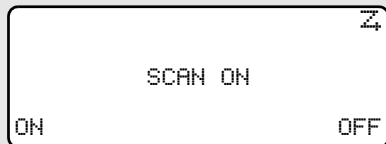

OR

To exit the display menu without changing the scan state, press  or PTT.

Use the Preprogrammed Scan On/Off Switch

Place the **Scan On/Off** switch in the Scan On or Scan Off position. The current scan state is displayed. When scan is on, the scan status symbol (Z) is displayed.



Note: To exit the display menu without changing the scan state, press (M) or **PTT**.

Delete a Nuisance Channel

When the radio scans to a channel that you do not wish to hear (nuisance channel), you can temporarily delete the channel from the scan list.

- 1** When the radio is locked onto the channel to be deleted, press the preprogrammed **Nuisance Delete** button.
Repeat this step to delete more channels.

Note: You cannot delete priority channels or the designated transmit channel.

- 2** The radio continues scanning the remaining channels in the list. To resume scanning the deleted channel, change channels or turn scan off and then back on again.
-

Conventional Scan Only

Make a Dynamic Priority Change

While the radio is scanning, the dynamic priority change feature lets you *temporarily* change any channel in a scan list (except the priority-one channel) to the priority-two channel. The replaced priority-two channel becomes a non-priority channel. This change remains in effect until scan is turned off, then scanning reverts back to the preprogrammed state.

- 1 When the radio is locked onto the channel to be designated as priority-two, press the preprogrammed **Dynamic Priority** button.

Note: The priority-one channel cannot be changed to priority-two.

- 2 The radio continues scanning the remaining channels in the list. To resume scanning the preprogrammed priority-two channel, you must leave and re-enter scan operation.
-

Telephone Calls (Trunking Only)

Use your radio to make and receive standard phone calls. A landline phone can be used to call a radio, or a radio can be used to call a landline phone.

Answer a Phone Call

Use the Preprogrammed Call Response Button

- 1 When a phone call is received, you hear a telephone-type ringing, the LED blinks GREEN, the call-received symbol (☎) blinks, and PHONE CALL is displayed.

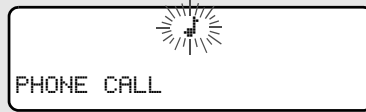

- Telephone ringing
- Blinking GREEN LED

- 2 Press the **Call Response** button within 20 seconds after the call indicators begin.

- 3 Press and hold the **PTT** button to talk; release it to listen.

- 4 Press (⏏) to hang up and return to the home display.

Make a Phone Call

Use the Menu

- 1 Press  to find PHON.

PHON





- 2 Press , , or  directly below PHON.

The last phone number dialed is displayed.

555-1234

LIST

- Note:** If you wish to call this number, go to Step 4. Otherwise, continue to Step 3.

- 3 Press  or  to scroll to the phone number you want in the list. Press , , or  directly under LNUM to go to the last phone number dialed.

POLICE

555-8523

LNUM

- 4 Press and release the **PTT** button to start the phone call to the displayed number.

OR

Press the preprogrammed **Quick Access** button to start the phone call to the displayed number.







5 Press and hold the **PTT** button to talk, release it to listen.

OR

If your call is not answered, go to “Phone Call Display and alert Prompts” on page 49.

6 Press  to hang up and return to the home display.

Phone Call Display and Alert Prompts

<ul style="list-style-type: none"> When you press the PTT button and the phone system is not available, a long tone sounds. Press  to hang up. Radio returns to the home display. 	
<ul style="list-style-type: none"> When a channel is not available, a busy tone sounds. The radio will automatically connect when a channel opens. 	
<ul style="list-style-type: none"> When the phone system is busy, a long tone sounds. Try your call later. Press  to hang up. Radio returns to the home display. 	
<ul style="list-style-type: none"> The system does not acknowledge your call. Press  to hang up. Radio returns to the home display. 	
<p>Notes:</p> <ul style="list-style-type: none"> A high-pitched tone, generated when you release the PTT button, indicates to the landline party that he or she can begin talking. You have the option of sending additional digits (overdial), such as an extension number, or credit card or PIN numbers, to the phone system. If the radio is programmed for live overdial, every digit entered after the call is connected is sent to the phone system. If the radio is programmed for buffered overdial, the digits pressed are entered into memory and then sent when the PTT button is pressed. Press the PTT to send either digits or voice, but not both at the same time. 	

Private Calls (Trunking Only)

These one-to-one calls between two radios are not heard by others in the current talkgroup. The calling radio automatically verifies the receiving radio is active on the system and can display the caller's ID.

Answer a Private Call

Use the Preprogrammed Call Response Button.

- 1 When a private call is received, you hear two alert tones, the LED blinks GREEN, the call-received symbol (☎) blinks, and CALL RECEIVED is displayed.



- Two tones
- Blinking GREEN LED

- 2 Press the **Call Response** button within 20 seconds.

If the caller's name is in the call list, it will be displayed.

OR

If the name is not in the call list, the caller's ID number is displayed.

- 3 Press and hold the **PTT** button to talk; release it to listen.



- 4 Press  or the **Call Response** button to hang up.
-

Make a Private Call

Use the Menu



- 1 Press  to find CALL.

CALL

- 2 Press , , or  directly below CALL.

You see the last transmitted or received ID number

FIRE CHIEF
ID: 701234
LIST

- 3 Press  or  to scroll to the ID number you want in the list.

FIRE CHIEF
ID: 701234
LNUM

Note: Press LNUM to go to the last number dialed.

- 4 Press the **PTT** button to start the Private Call to the displayed number.

OR

Press the preprogrammed **Quick Access** button to start the private call to the displayed number.

- 5 The called ID is momentarily displayed, followed by PLEASE WAIT. The called ID is displayed once connected.

PLEASE WAIT

If the system does not acknowledge the call, NO ACKNOWLEDG is displayed.

NO ACKNOWLEDG

If the target radio does not respond before the time out, NO ANSWER is displayed.

NO ANSWER

Call Alert Paging

Call Alert allows your radio to work like a pager. Even if other users are away from their radios, or if they are unable to hear their radios, you can still send them a Call Alert page. With Call Alert paging, you can also verify if a radio is active on the system.

Answer a Call Alert Page

- 1 When a Call Alert Page is received, you hear four repeating alert tones, the LED blinks GREEN, the call-received symbol (📞) blinks, and PAGE RECEIVED is displayed.



- Four repeating alert tones
- Blinking GREEN LED



- 2 Press and hold the **PTT** button to talk, release it to listen.
-

Make a Call Alert

Use the Menu

- 1 Press  to find PAGE.

PAGE

- 2 Press , , or  directly below PAGE.

You see the last transmitted or received ID number.

FIRE CHIEF
ID: 701234
LIST

Note: Press LNUM to go to the last number dialed.

FIRE CHIEF
ID: 701234
LNUM

- 3 Press the **PTT** button to start the Call Alert Page to the displayed number.

OR

Press the preprogrammed **Quick Access** button to start the page to the displayed number.

PLEASE WAIT is displayed. The home display appears once you are connected.

PLEASE WAIT

If the system does not acknowledge the call, NO ACKNOWLEDG is displayed. The radio exits Call Alert and returns to normal operation.

NO ACKNOWLEDG

- 4 Press  to hang up and return to the home display.



Conventional Talkgroup Calls (Conventional Operation Only)

Talkgroup Call lets you define a group of conventional system users so that they can share the use of a conventional channel.



Select a Talkgroup



- 1 Press  to find TGRP.



- 2 Press , , or  directly below TGRP.

The last user-selected-and-stored talkgroup, and its available softkeys, are displayed.

- 3 Press  or  to find the talkgroup you want.

- 4 Press , , or  directly below PSET (to select the preset or programmed talkgroup), or below SEL (to save the talkgroup and return to the home display).



- 5 To exit, press  or the **PTT** button, or turn the **16-Position Select** knob.

Repeater or Direct Operation

Also known as TALKAROUND operation, DIRECT lets you bypass the repeater and connect directly to another radio. The transmit and receive frequencies are the same.



REPEATER operation increases the radio's range by connecting with other radios through a repeater. Transmit and receive frequencies are different.

Select Repeater or Direct Operation





Use the Menu

- 1 Press  to find DIR.

DIR

- 2 Press , , or  directly below DIR. The current operation is momentarily displayed.

DIRECT MODE or RPTR MODE
DIR RPTR DIR RPTR

- 3 Press , , or  directly below DIR or RPTR. If DIR is selected, the display shows  and DIRECT MODE.

I+I
DIRECT MODE

- 4 Press  to exit display menu without changing the current operation.

Special Radio Features

PTT ID

Receive



This feature allows you to see the radio ID number of the radio you are currently receiving. This ID can be a maximum of eight characters and can be viewed by both the receiving radio and the dispatcher.

Transmit

Your radio's ID number is automatically sent every time the **PTT** button is pressed. This is a per-channel feature. For digital voice transmissions, your radio's ID is sent continuously during the voice message.

View Your Radio's ID Number



Use the Menu

- 1 Press  or  to find CALL or PAGE.

CALL

or

PAGE

- 2 Press , , or  directly below CALL or PAGE.

- 3 Press .

MY ID:

701111

Use the Preprogrammed Call or Page Button

- 1 Press the **Call** or **Page** button.

- 2 Press .

MY ID:

701111

Dynamic Regrouping (Trunking Only)

The dynamic regrouping feature lets the dispatcher temporarily reassign selected radios to a single special channel so they can communicate with each other. This feature is typically used during special operations and is enabled by a qualified radio technician. You will not notice whether your radio has this feature enabled until a dynamic regrouping command is sent by the dispatcher.

Note: If you try to access a zone or channel that has been reserved by the dispatcher as a dynamically regrouped mode for other users, you will hear an invalid tone.

When your radio is dynamically regrouped, it automatically switches to the dynamically regrouped channel. You see the dynamically regrouped channel's name, and hear a "gurgle" tone.

Press the **PTT** button to talk; release it to listen.

When the dispatcher cancels dynamic regrouping, the radio automatically returns to the zone and channel that you were using before the radio was dynamically regrouped.

Reprogram Request (ASTRO 25 Trunking Only)

This feature lets you notify the dispatcher that you want a new dynamic regrouping assignment.

Use the Menu

1 Press  to find RPGM.

RPGM

2 Press , , or  directly below RFGM.

REPRGRM ROST

The reprogram request is sent to the dispatcher.

3 If you hear *one beep* • One beep

- Press the **PTT** button to send the reprogram request again.

OR

- Press  to cancel and return to the home display.

OR

If you hear *five beeps*, the reprogram request was acknowledged by the dispatcher. Your radio returns to the home display. • Five beeps

OR

If the dispatcher does not acknowledge the reprogram request within six seconds, you see **NO ACKNOWLEDG** and hear a low-pitched alert tone.

NO ACKNOWLEDG

- An alert tone

Try again or press .

Use the Preprogrammed Reprogram Request Button

1 Press the **Reprogram Request** button. You see **REPRGRM RQST**.

REPRGRM RQST

The reprogram request is sent to the dispatcher.

- 2 If you hear *one beep*
- One beep
 - Press the **PTT** button to send the reprogram request again

OR

- Press  to hang up and return to the home display.

OR

- If you hear *five beeps*, the reprogram request was acknowledged by the dispatcher. Your radio returns to the home display.
- Five beeps

OR

If the dispatcher does not acknowledge the reprogram request within six seconds, you see **NO ACKNOWLEDG** and hear a low-pitched alert tone.

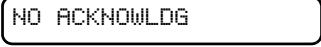

NO ACKNOWLEDG

- An alert tone

Try again or press .

Select Enable / Disable

The dispatcher can classify regrouped radios into either of two categories: Select Enabled or Select Disabled.

- Select-enabled radios are free to change to any available channel, including the dynamic-regrouping channel, once the user has selected the dynamic-regrouping position.
- Select-disabled radios cannot change channels while dynamically regrouped. The dispatcher has forced the radio to remain on the dynamic-regrouping channel.

The Scan or Private Call feature cannot be selected while your radio is Select Disabled.

Trunking System Controls

Failsoft

The failsoft system ensures continuous radio communications during a trunked system failure. If a trunking system fails completely, the radio goes into failsoft operation and automatically switches to its failsoft channel.

During failsoft operation:

Your radio transmits and receives in conventional operation on a predetermined frequency.



FAILSOFT

You hear a medium-pitched tone every 10 seconds.

- Medium-pitched tone

When the trunking system returns to normal operation, your radio automatically leaves failsoft operation and returns to trunked operation.

Out-of-Range

If you go out of the range of the system, and can no longer lock onto a control channel:

The display shows OUT OF RANGE and the currently selected zone/channel combination, and/or you hear a low-pitched tone.



OUT OF RANGE

AND/OR

Your radio remains in this out-of-range condition until it locks onto a control channel, or it locks onto a failsoft channel, or it is turned off.

- Low-pitched tone
- Locks onto a control channel, or
- Locks onto a failsoft channel, or
- Turned off.

Site Lock

This feature allows your radio to lock onto a specific site and not roam among wide-area talkgroup sites. This feature should be used with caution, since it inhibits roaming to another site in a wide-area system.

Lock or Unlock a Site

Use the Menu

- 1 Press or to find SITE.



SITE

- 2 Press , , or directly below SITE.

The current lock state is displayed.

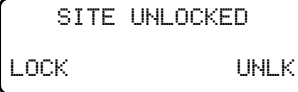

SITE UNLOCKED
LOCK UNLK

OR

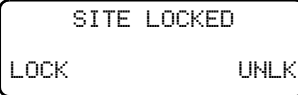

SITE LOCKED
LOCK UNLK

- 3 Press , , or directly below LOCK or UNLK.

- The new site-lock state is saved.
- Your radio returns to the home display.

Use the Preprogrammed Site Lock/Unlock Button

- 1 Press the **Site Lock/Unlock** button.

The current lock state is momentarily displayed.



SITE LOCKED

OR



SITE UNLOCKED

- 2 Press and hold the **Site Lock/Unlock** button until you see the desired lock state.



SITE LOCKED

OR



SITE UNLOCKED

Site Trunking

If the zone dispatcher loses communication with any site, that site reverts to “site trunking.” The display shows `SITE TRUNKING` and the currently selected zone/channel combination. When this occurs, you can communicate only with other radios within your trunking site.

Site View and Change

You can view the ID number of the current site or force your radio to change to a new one.

View the Current Site

Momentarily press the preprogrammed **Site Search** button.

The display shows either the number of the current site and its corresponding Received Signal Strength Indicator (RSSI) symbol () (See Table 2 on page 7).



The screenshot shows a rounded rectangular display area. At the top left, there is an RSSI symbol consisting of a vertical bar followed by four horizontal bars of increasing height. Below this, the text "SITE 2" is displayed in a monospaced font.

OR

If the radio is scanning for a new site, the display momentarily shows `SCANNING SITE`.



The screenshot shows a rounded rectangular display area with the text "SCANNING SITE" displayed in a monospaced font.

Change the Current Site

Press and hold down the preprogrammed **Site Search** button to manually force the change to a new site.

You hear a tone, and the display shows `SCANNING SITE` while the radio scans for a new site.

- Tone



The radio returns to the home display when it finds a new site.

Time and Date

Using this special feature, you may program the time and date as you might with other electronic devices. The clock display is enabled by a qualified radio technician.

- The default time setting is a 12-hour clock.
- If a 24-hour clock is selected, AM/PM selection is not available.
- The default setting for the domestic date shows MDY.

12HR 00:00AM

MDY 00/00/00

Edit Time and Date

- 1 Press to find **CLCK**.

CLCK

- 2 Press , , or directly below **CLCK**. The current setting is displayed.

12HR 03:54AM
MDY 03/07/01
EDIT

- 3 Press , , or directly below **EDIT**. The first item blinks.

12HR 03:54AM
MDY 03/07/01
SAVE

- 4 Press or to change the selected item.



24HR 03:54
MDY 03/07/01
SAVE

Note: Press  at any time to return to the home display without saving your changes.

OR

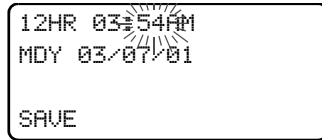
Press  one or more times to move to an item you wish to change.



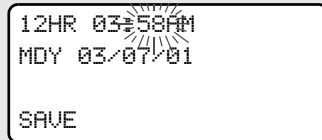

5 Press  or  to change the selected item.



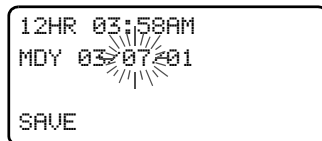

6 Press  one or more times to move to an item in the date field.

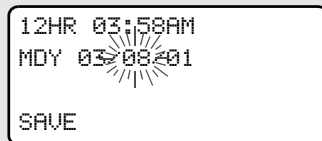

7 Press  or  to change the selected item.



8 When you have made all your changes, press , , or  directly below SAVE to save your changes and return to the Home display.

Note: If a call arrives while the radio is in the clock-setting menu, the radio exits clock setting, your changes are lost, and the call information is displayed.

Outdoor Location (using GPS)

The Outdoor Location (using GPS) feature allows radio users to determine their current location using a location menu. Radio location may be requested and reported over-the-air.



This feature is only available when a location enabled accessory such as the GPS Remote Speaker Microphone (RSM) is attached to the radio.

Access the Location Feature Use the Menu

- 1 Press  to find LOC.



LOC

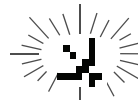
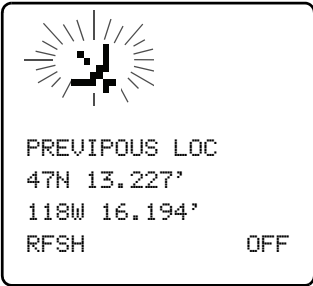

- 2 Press , , or  directly below LOC.
If radio has just been switched on, or no location signal is available (blinking icon), the display shows the latitude and longitude of the last successful location fix. The top line will display PREVIOUS LOC.
As soon as a location signal is detected (solid icon), the display will be updated with the new location coordinates. The location coordinates will be updated automatically every four minutes while the location signal is present.

PREVIOUS LOC
47N 13.227'
118W 16.194'
RFSH OFF

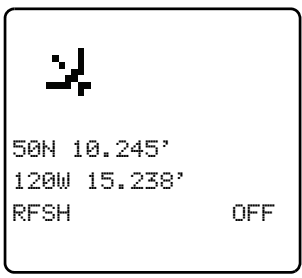





50N 10.245'
120W 15.238'
RFSH OFF



- 3 Press , , or  directly below RFSH to obtain a new location fix. The top line will temporarily display PLEASE WAIT while the new location is being determined.

Note: While the new location is being determined, the location signal can be solid or blinking icon.





- 4 Press , , or  directly below OFF to disable the location feature to save battery power.

OR

- Press , , or  directly below ON to enable the location feature.

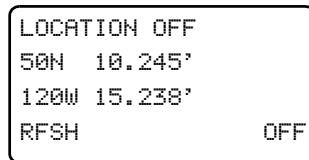
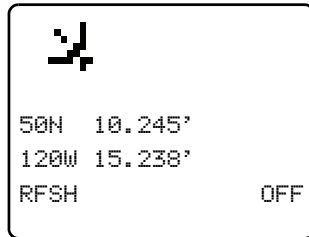
Note: An ON/OFF menu key may be present on the location menu if it is programmed by the service technician.



- 5 Press  or the PTT button to exit this menu. If the emergency button is pressed or the GPS RSM is disconnected, radio will also exit this menu.

Location and Emergency Feature Interaction

When the Emergency feature is activated by pressing the emergency button, the radio will exit the Location menu and return to the home (default) display so that you can see which channel the emergency signal is going out on. However, you may re-enter the Location menu while still in emergency mode, provided that Silent Emergency has not been activated.

If you have turned Location off using the ON/OFF menu key, it will be automatically turned back on when Emergency is activated.

GPS Enabled

Your RSM's GPS Enabled feature uses information from the Global Positioning System (GPS) satellites orbiting the Earth to determine the approximate geographical location of your RSM, expressed as latitude and longitude. The availability and accuracy of this location information (and the amount of time that it takes to calculate it) will vary depending on the environment in which you are using the GPS feature.

For example, GPS location fixes are very difficult to obtain indoors, in covered locations, between high buildings, or in situations where you have not established a clear broad view of the sky.

IMPORTANT: Things to Keep in Mind

The GPS technology uses radio signals from earth orbiting satellites, to establish the location co-ordinates, maximizing your view of clear unobstructed sky is essential for optimum performance. Where adequate signals from multiple satellites are not available (usually because you cannot establish a view of a wide area of the sky), the GPS feature of your RSM will not work. Such situations include but are not limited to:

- In underground locations
- Inside of buildings, trains, or other covered vehicles
- Under any other metal or concrete roof or structure
- Between tall buildings or under dense tree-cover
- In temperature extremes outside the operating limits of your RSM

Even where location information can be calculated in such situations, it may take longer to do so, and your location estimate may not be as accurate. Therefore, in any emergency situation, always report your location to your dispatcher.

Furthermore, please note that even where adequate signals from multiple satellites are available, your GPS feature will only provide an approximate location, often within 20 – 100 meters from your actual location, but sometimes much further from the actual location.

Keep in mind that the accuracy of the location information and the time it takes to obtain it varies depending upon circumstances, particularly the ability to receive signals from an adequate number of satellites.

The satellites used by the GPS feature are controlled by the U.S. government and are subject to changes implemented in accordance with the Department of Defense GPS user policy and the Federal Radio Navigation Plan. These changes may affect the performance of the GPS feature on your RSM.

Enhancing GPS Performance

Sometimes, the GPS feature of your RSM may be unable to complete a location calculation successfully. You will then see a message indicating that your RSM cannot see enough visible satellites. To maximize the ability of your RSM to determine a fix, please note the following guidelines:

- Stay in the open. The GPS feature works best where there is nothing between your RSM and a large amount of open sky.
- Wear your RSM outside all clothing. Keep it as high on your body as possible, ideally at shoulder level.

ARS User Login and Text Messaging Features

Automatic Registration Service (ARS)

The Automatic Registration Service feature provides an automated data application registration for the radio. When you turn on the radio, the device automatically registers with the server. Data applications within the fixed network can determine the presence of a device on the system and send data to the device. For example: Text Messaging Service (TMS).

The Automatic Registration Service for the radio consists of 2 modes:

- ARS Server Mode (default mode)
- ARS Non Server Mode

Note: The default ARS mode can be changed by a qualified radio technician using the radio's programming software.

Selecting or Changing ARS Mode

Consult a qualified radio technician for the right choice between the following methods:

Method 1: Use the Preprogrammed 16-Position Select Knob

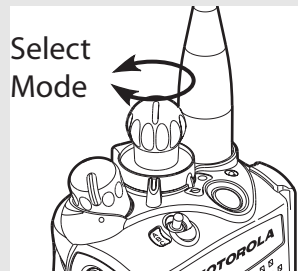

After the zone you want is displayed, turn the **16-Position Select** knob to the desired mode.



Method 2: Use the Menu

- 1 Press  to find CHAN.

CHAN

- 2 Press , , or  directly below CHAN.

The display shows the current channel name (in this case, NONSUR) blinking and the zone (Z1), not blinking.

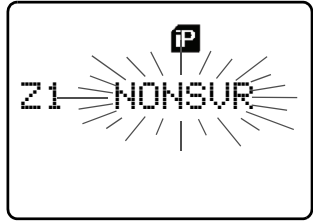

- 3 Press  to find the channel/mode you want.

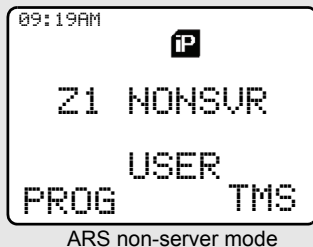
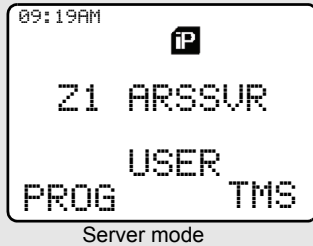

Note: If the channel/mode you selected is unprogrammed, repeat step 3.





- 4 Press  to confirm the displayed zone and channel.
-

ARS User Login Feature

The user login feature allows you as the user to be associated with the radio. With this association, every data application (Example: Text Messaging Service) will take on a friendly username. You can still send text messages without logging in as a user. The user login feature only enables the recipient of your message to identify you as the sender by assigning a username to your message.

Accessing the User Login Feature

The user login feature can be accessed by selecting a menu item on the display or through a programmable button.

- 1 Press  until USER appears on the display.
- 2 To access the user login screen through the menu item, press  below USER.

To access the user login screen through a preprogrammed button, press the preprogrammed user button.

Note: Radio buttons that are “preprogrammed” mean that a qualified radio technician must use the radio’s programming software to assign a feature to a button. Any programmable buttons on the radio can be programmed to access the user login feature. See “Physical Features of the XTS 2500 / XTS 2500I Model II Radio” on page 4.

- 3 The user login screen appears.

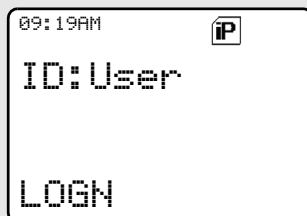



To Login as a User

1 Selecting a Predefined Username

Press  to scroll to the next username.

OR

Press  to scroll to the previous username.

Press and hold , to scroll to the next usernames continuously one at a time at a fast scroll rate.

OR

Press and hold , to scroll to the previous usernames continuously one at a time at a fast scroll rate.

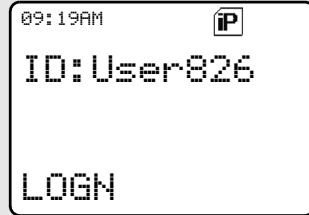

Note: Predefined username can be set using a programming software known as Customer Programming Software (CPS).

Note: Valid characters for a username entry are capital letters A – Z, small letters a – z, numbers 0 – 9, '*', '#', '-', '/' and the space character. The maximum length for a username is 8 characters. Username will not be case sensitive in server mode and will be case sensitive in non-server mode.

- 2 If you log in with a selected predefined username comprising of 8 characters or more, or one with an invalid character, you will see a momentary text INVALID ID on the display.

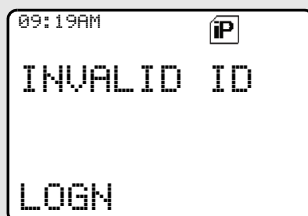

Note: A predefined username may sometimes be invalid because the programming software that is used to set predefined usernames allows you to set usernames comprising of 8 characters or more.

- 3 To log in :

Press  below LOGN.

In ARS server mode :

The progress screen appears.

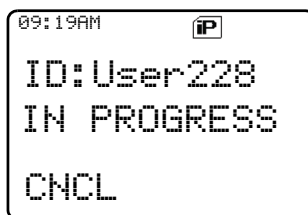

Server mode

In ARS non-server mode :

The logged in confirmation screen appears.

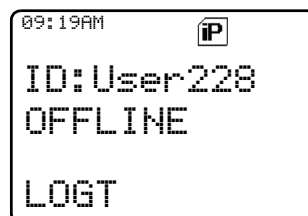

Non ARS enabled mode

In non-ARS enabled mode :

The display shows OFFLINE.

4 Press  below CNCL to cancel the login in progress screen and return to the initial user login screen.

5 The logged in confirmation screen appears when the login process is successful. The “successful user login” indicator (IP indicator) will be shown on the display.

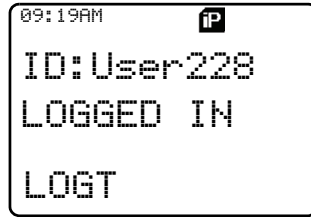

6 When you enter an invalid username or PIN, login fails and the user login screen will display a momentary text LOGIN FAILED. The “user login failure” indicator (blinking IP indicator) is shown on the display.

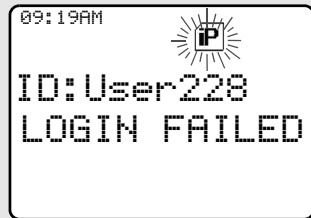

7 To log out :

Press below LOGT

Upon pressing the LOGT button, a confirmation screen appears.

Press below YES to clear all your private data. A momentary text PRIVATE DATA CLEARED is shown.

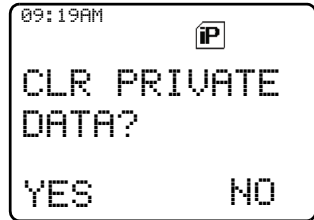

OR

Press below NO to keep your private data.

Note: Private data refers to all messages in the text messaging inbox and Sent folder. The next user will be able to access your Inbox and Sent messages if private data is not deleted.

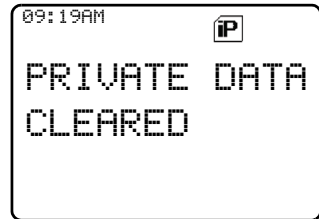



Text Messaging

The Text Messaging Service (TMS) is an application service through which you can send and receive text messages.

Accessing TMS Feature

Use the Menu

- 1 a) Press  until TMS appears on the display.
- b) Press  directly below TMS.

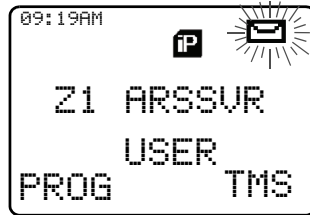

Use the TMS Feature Button

- 1 Press  to access the TMS feature screen.
-

Use the Preprogrammed TMS Button



- 1** Press the preprogrammed button to access the TMS feature screen.

Pressing and holding the preprogrammed button for TMS brings you directly to the Inbox screen.

Note: Any programmable button on the radio can be programmed to access TMS feature.

See “Physical Features of the XTS 2500 / XTS 2500I Model II Radio” on page 4 for more information on buttons that are programmable to access TMS.

- 2** The TMS feature’s main menu consists of the Inbox, Compose, Sent and Back option.
See “TMS Menu Options” on page 80 for explanation on each menu option.

Press  or  to scroll through the main menu options.

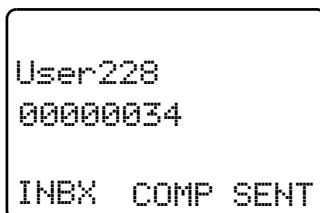









Table 7: TMS Menu Options

Menu Options	Description/ Function
INBX	This is used to store new incoming messages or messages that you have received. The Inbox can hold up to 30 messages.
COMP	This menu option brings you to the Quick Text Messages screen.
SENT	This is used to store the messages that you have already sent. The Sent folder can hold up to 10 messages.
BACK	This menu option brings you back to the TMS main menu or previous menu.
RPLY	This menu option allows you to reply to a message.
DEL	This menu option allows you to delete a message.
ADDR	This menu option allows you to select an address from the list.
IMPT	This menu option is used to toggle on/off the "Priority" flag for an outgoing message.
RGRP	This menu option is used to toggle on/off the "Request Reply" flag for an outgoing message.
CURR	This menu option is used to delete the current selected message.
ALL	This menu option is used to delete all the messages in the current message folder.

Table 8: TMS Status Symbols

Symbol	Indication
	<p>Priority Message This icon is displayed</p> <ul style="list-style-type: none"> • when “Priority” is toggled on before sending the message. • in the Inbox folder for messages which are flagged with “Priority”.
	<p>Request Reply This icon is displayed</p> <ul style="list-style-type: none"> • when “Request Reply” is toggled on before sending the message. • in the Inbox folder for messages which are flagged with “Request Reply”.
	<p>Inbox Full This icon is displayed when the Inbox folder is full.</p>
	<p>New Message Icon This icon is displayed when a new incoming message is received.</p>
	<p>Message Sent This icon indicates that the selected message has been successfully sent.</p>
	<p>Message Unsent This icon indicates that the selected message was not successfully sent.</p>

<i>Symbol</i>	<i>Indication</i>
	Read Message This icon is used to indicate that the selected message in the Inbox has been read.
	Unread Message This icon indicates that the selected message in the Inbox folder has not been read.
Inbox 3/6	Message Index This icon indicates the index of the current message the user is viewing. Example: if the user is looking at the third message out of a total of 6 messages in the Inbox folder, the icon is displayed as the icon on the left column.

Receive a Message

When you receive a message, a momentary text, NEW MSG appears on the display along with a new message icon.

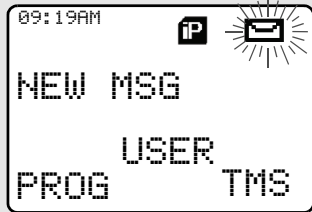

To View Message from the Inbox.

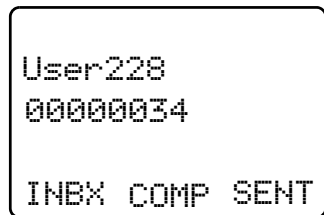

- 1 Access TMS (Launch TMS).
- 2 Press  directly below INBX.



- 3 The Inbox screen appears. The first message in the list is displayed. Inbox can hold up to 30 messages. Message status icons are displayed at the top of the screen. See “TMS Status Symbols” on page 81 for further details on these icons.



- 4 Scroll to the message you want to read by pressing the  button.

Note: If the message fills more than one screen, scroll to read it by pressing  or  button.

- 5 To delete the message, press  below DEL. See “Delete a Message” on page 87 for further details.

Send a Predefined Message

The Quick Text Messages are messages that are predefined and usually consist of messages that are used most frequently.



- 1 Press  below COMP to use the predefined message

OR

Press on the preprogrammed Quick Text button.

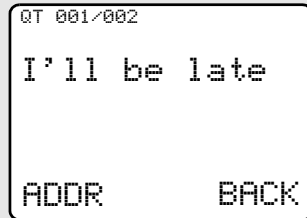
The first predefined message appears.



- 2 Press  or  to scroll through the list of predefined messages.

Note: Any programmable button on the radio can be programmed to access the Quick Text Messages feature.



See “Physical Features of the XTS 2500 / XTS 2500I Model II Radio” on page 4 for more information on buttons that are programmable to access Quick Text Messages.

- 3 When a message has been selected from the list, address your message and press the PTT button to send the message.

4 Addressing a Message

Press  below ADDR to address your outgoing message.

The Address input screen appears.

Press  or  to scroll through the address list.

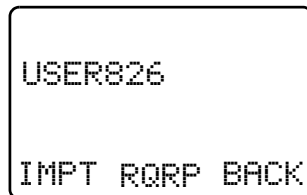

5 Append a Priority Message or Request Reply

Before sending your message, you can append a priority message or a request reply to your message.

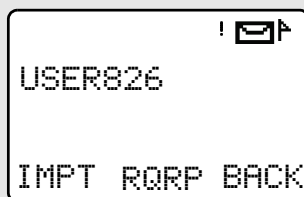

Press  below **IMPT** to toggle on/off a “Priority” flag for an outgoing message. A “Priority” flag icon is displayed at the top of the screen when it is toggled on. See “TMS Status Symbols” on page 81.

Press  below **RQRP** to toggle on/off the “Request Reply” icon for an outgoing message. A “Request Reply” status icon is displayed at the top of the screen when it is toggled on. See “TMS Status Symbols” on page 81.

Note: When you received a message on the XTS 5000 radio that is flagged with the “Request Reply” icon, you must manually respond to the sender that you have received the message. The system will not automatically send back a notification that the radio received such message.



Note: The “Priority” flag on a message does not imply that the message will get higher priority over the other messages when it is being transmitted. It is just an indication that can be embedded into a message to let the receiver know that the message is important.

- 6 When an address has been appended to the outgoing message, press the **PTT** button to send your message.

Reply to a Received Message

- 1 Press  below RPLY to reply to a message.
The Quick Text Message Screen appears.
The first predefined message appears.



- 2 Press  or  to scroll through the list of predefined messages.
- 3 When a message has been selected from the list, press the PTT button to send the message.

Delete a Message

1 From the Inbox or Sent screen, scroll to select a message for deletion.

2 After selecting a message, press below DEL. The display shows 2 delete options.

Press below CURR to delete only the current message.

```
INBOX 001/002
FROM:User228
Hello
CURR ALL BACK
```

OR

Press below ALL to delete all messages.

3 When you select to delete all messages, a confirmation screen appears.

Press below YES to delete all messages.



```
INBOX 001/002
DEL ALL?
YES NO BACK
```

To Access the Sent Folder

The Sent folder stores the messages that were sent out previously. The Sent folder can hold up to 10 messages. The oldest Sent message in the folder is deleted when the 11th message comes in.

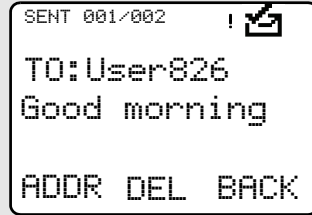
- 1 Press  below SENT. The Sent screen appears. The first sent message in the list is displayed. A message delivery icon will be displayed at the top right corner of the screen. See “TMS Status Symbols” on page 81 for more details.



- 2 Press  or  to scroll through the list of other messages that have been sent.
-

Helpful Tips

Radio Care

Cleaning

To clean the external surfaces of your radio:

- 1 Combine one teaspoon of mild dishwashing detergent to one gallon of water (0.5% solution).
- 2 Apply the solution sparingly with a stiff, non-metallic, short-bristled brush, making sure excess detergent does not get entrapped near the connectors, controls or crevices. Dry the radio thoroughly with a soft, lint-free cloth.
- 3 Clean battery contacts with a lint-free cloth to remove dirt or grease.



Caution

Do not use solvents to clean your radio. Spirits may permanently damage the radio housing.

Do not submerge the radio in the detergent solution.

Handling

- Do not pound, drop, or throw the radio. Never carry the radio by the antenna.
- Avoid subjecting the radio to an excess of liquids.
- Avoid subjecting the radio to corrosives, solvents or spirits.
- Do not disassemble the radio.
- Keep the accessory-connector cover in place until ready to use the connector. Replace the cover immediately once the accessory has been disconnected.

Service

Proper repair and maintenance procedures will assure efficient operation and long life for this product. A Motorola maintenance agreement will provide expert service to keep this and all other communication equipment in perfect operating condition. A nationwide service organization is provided by Motorola to support

maintenance services. Through its maintenance and installation program, Motorola makes available the finest service to those desiring reliable, continuous communications on a contract basis. For a contract service agreement, please contact your nearest Motorola service or sales representative, or an authorized Motorola dealer.

Express Service Plus (ESP) is an optional extended service coverage plan, which provides for the repair of this product for a period of three years from the date of shipment from the factory, or the date of delivery if purchased from an authorized Motorola two-way radio dealer. For more information about ESP, contact the Motorola Radio Support Center, 2204 Galvin Drive, Elgin, IL 60123, 1-800-227-6772.

Battery

Battery Life

Battery life is determined by several factors. Among the more critical are the regular overcharge of batteries and the average depth of discharge with each cycle. Typically, the greater the overcharge and the deeper the average discharge, the fewer cycles a battery will last. For example, a battery which is overcharged and discharges 100% several times a day, will last fewer cycles than a battery that receives less of an overcharge and is discharged to 50% per day. Further, a battery which receives minimal overcharging and averages only 25% discharge, will last even longer.

Charging the Battery

Motorola batteries are designed specifically to be used with a Motorola charger and vice-versa. Charging in non-Motorola equipment may lead to battery damage and void the battery warranty. Motorola-authorized battery chargers may not charge batteries other than the ones listed on page 96.

The battery should be at about 77 °F (25 °C) (room temperature), whenever possible. Charging a cold battery (below 50 ° F [10 °C]) may result in leakage of electrolyte and ultimately in failure of the battery. Charging a hot battery (above 95 °F [35 °C]) results in reduced discharge capacity, affecting the performance of the radio.

Motorola rapid-rate battery chargers contain a temperature-sensing circuit to ensure that batteries are charged within the temperature limits stated above.

Battery Charge Status

Your radio can indicate your battery's charge status by the following:

LED and Sounds

- you see the LED flash red when the PTT Button is pressed indicating low battery
- you hear a low-battery “chirp” (short, high-pitched tone)





Conventional Fuel Gauge Symbol

A blinking fuel gauge symbol () is displayed only when the battery voltage drops to low level. In this case, replace the battery with a fully charged one.

Smart Fuel Gauge Symbol

Note: Smart battery will be available at a future date.

Consult the Smart Battery manual. All conditions must be met for a battery to be classified as a “Smart Battery.” When your radio has a Smart Battery installed, the fuel gauge symbol is always displayed.

Gauge shows:	if the battery's charge is:
	71% to 100% full
	41% to 70%
	11% to 40%
	10% or less (at 10%, the gauge begins blinking)

Replace the battery with a fully charged one when the fuel gauge shows the lowest level.

Battery Recycling and Disposal

Nickel-cadmium (NiCd) rechargeable batteries can be recycled. However, recycling facilities may not be available in all areas. Under various U.S. state laws and the laws of several other countries, NiCd batteries must be recycled and cannot be disposed of in landfills or incinerators. Contact your local waste management agency for specific requirements and information in your area.

Motorola fully endorses and encourages the recycling of NiCd batteries. In the U.S. and Canada, Motorola participates in the nationwide Rechargeable Battery Recycling Corporation (RBRC) program for NiCd battery collection and recycling. Many retailers and dealers participate in this program.

For the location of the drop-off facility closest to you, access RBRC's Internet web site at www.rbrc.com or call 1-800-8-BATTERY. This internet site and telephone number also provide other useful information concerning recycling options for consumers, businesses, and governmental agencies.

Antenna

Radio Operating Frequencies

Before installing the antenna, make sure it matches your radio's operating frequency. Antennas are frequency sensitive and are color coded according to their frequency range. The color code indicator is located in the center of the antenna's base.

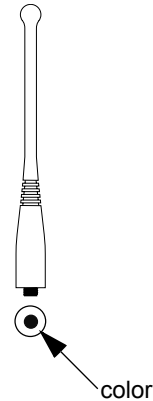

The following antenna types are compatible with your radio:

Antenna Type	Approx. Length		Insulator Color Code	Frequency Range (MHz)	Antenna Kit No.
	in.	mm			
VHF whip	8	203	RED	136 – 174	NAD6563
VHF helical	7.6	193	YELLOW	136 – 150.8	NAD6566
VHF helical	7	178	BLACK	150.8 – 162	NAD6567
VHF helical	6.5	165	BLUE	162 – 174	NAD6568
UHF helical	3.3	83	RED	380 – 435	NAE6546
UHF helical	3.1	78	GREEN	435 – 470	NAE6547
UHF helical	2.8	71	BLACK	470 – 520	NAE6548
UHF whip, wideband	5.2	133	GRAY	380 – 520	NAE6549

Helpful Tips

Antenna Type	Approx. Length		Insulator Color Code	Frequency Range (MHz)	Antenna Kit No.
	in.	mm			
800 MHz whip, halfwave	7	178	RED	806 – 870	NAF5037
800 MHz dipole	8	200	RED	806 – 870	NAF5039
800MHz stubby, quarterwave	3.4	85	WHITE	806 – 941	NAF5042
700/800 MHz whip	7	178	GREEN	764 – 870	NAF5080

Accessories

Motorola provides the following approved accessories to improve the productivity of your XTS 2500 / XTS2500I portable two-way radio.

For a list of Motorola-approved antennas, batteries, and other accessories, visit the following web site which lists approved accessories: <http://www.motorola.com/governmentandenterprise>

Antennas

NAD6563	VHF whip (136 – 174 MHz)
NAD6566	VHF (136 – 150.8 MHz)
NAD6567	VHF (150.8 – 162 MHz)
NAD6568	VHF (162 – 174 MHz)
NAE6546	UHF (380 – 435 MHz)
NAE6547	UHF (435 – 470 MHz)
NAE6548	UHF (470 – 520 MHz)
NAE6549	UHF whip (380 – 520 MHz)
NAF5037	800 MHz whip, halfwave (806 – 870 MHz)
NAF5039	800 MHz dipole (806 – 870 MHz)
NAF5042	800 MHz stubby, quarterwave (806 – 941 MHz)
NAF5080	700/800 MHz whip (764 – 870 MHz)

Batteries

NTN9815	NiCd high-capacity
NTN9816	NiCd high-capacity, Factory Mutual Intrinsically Safe
*NTN9857	NiMH ultra-high-capacity, Factory Mutual Intrinsically Safe, IMPRES
*NTN9858	NiMH ultra-high-capacity, IMPRES
*NNTN6263	JedRay NiMH FM, Battery Immersible, IMPRES

** Batteries include an over-discharge protection circuit (similar to those in Li-Ion batteries) to extend life of batteries by preventing excessive battery discharge during customer use. Motorola strongly recommends charging these batteries with Motorola-approved IMPRES desktop charges programmed with version 3.4 of the IMPRES desktop charger software.*

Carry Accessories

Belt Clips

HLN6853	Belt clip, 2 1/4 inch
---------	-----------------------

Body-Worn

NNTN4115	Carrying case, leather with 3-in. swivel belt loop and T-strap
NNTN4116	Carrying case, leather with 2.5-in. swivel belt loop and T-strap
NNTN4117	Carrying case, leather with 3-in. belt loop and T-strap
NLN6349	Shoulder strap for carrying radio
NTN5243	Shoulder strap for carrying radio
TDN9675	Wrist strap for carrying radio

Chargers

NLN7967	Wall-mount kit for multi-unit charger
NLN7968	Rack-mount kit for multi-unit charger
NTN1168	Single-unit dual rate, rapid charger 120 V
NTN1169	Single-unit dual rate, rapid charger 220 V (2-prong Euro plug)
NTN1170	Single-unit dual rate, rapid charger 240 V (3-prong UK plug)
NTN1177	Multi-unit, dual rate, rapid charger 110 V
NTN1178	Multi-unit, dual rate, rapid charger 240 V (3-prong UK plug)
NTN1179	Multi-unit, rapid charger 240 V (UK 13 MAP Plug)
NTN1667	Tri-chemistry, 110 V
NTN1668	Tri-Chemistry, 220 V Single Unit Charger (2 Prong Euro Plug)
NTN1669	Tri-chemistry, 230 V
NTN1873	IMPRES™ rapid charger 110 V single-unit
NTN1874	IMPRES™ rapid charger 220 V single-unit
NTN1875	IMPRES™ rapid charger 240 V single-unit
NTN4796	Multi-unit, tri-chemistry, rapid rate, 110 V
NTN7209	Single-unit dual rate, rapid charger without cord
RLN4884	Single-unit Travel Charger

Enhanced and Multi-Unit Line Cords

NTN7373	110 V interchangeable line
NTN7374	220 V interchangeable line (2-prong Euro plug)
NTN7375	240 V interchangeable line (3-prong UK plug)

Microphones, Remote Speaker

NMN6191	Remote speaker mic, noise-canceling (includes 6.0-ft coiled cord assembly, 3.5-mm earjack, swivel clip, quick disconnect)
NMN6193	Remote speaker mic
NNTN4285	Remote speaker mic adapter
ZMN6031	Speaker mic, 3-piece
ZMN6032	Speaker mic, 2-piece
ZMN6038	Speaker mic, 2-piece, extra loud
ZMN6039	Speaker mic, 3-piece, extra loud
*RMN5074	18 inch Public Safety Microphone
*RMN5073	24 inch Public Safety Microphone
*RMN5072	30 inch Public Safety Microphone

Note: Accessories *RMN5074, *RMN5073 and *RMN5072 are not to be used with VHF band radios. For 900MHz band radios, use these accessories only with antenna NAF5042.

Surveillance Accessories

Adapters and Adapter Cable

BDN6673	Headset adapter cable (for use with BDN6635 and BDN6645)
BDN6676	Jedi adapter
NTN8613	Surveillance accessory adapter

CommPort[®] Integrated Microphone/Receivers

NTN1624	CommPort with palm PTT
NTN1625	CommPort ear mic with PTT for noise levels up to 100 dB (requires BDN6676 adapter)
NTN1663	CommPort ear mic with ring PTT for noise levels up to 100 dB (requires BDN6676 adapter)
NTN1736	CommPort ear mic with snap-on side PTT for noise levels up to 100 dB (requires BDN6676 adapter)

Earpieces

BDN6641	Ear mic, high noise level up to 105 dB, grey (must order BDN6671 interface module)
BDN6664	Earpiece with standard earphone, beige
BDN6665	Earpiece with extra-loud earphone (exceeds OSHA limits), beige
BDN6666	Earpiece with volume control, beige
BDN6667	Earpiece, mic and PTT combined, beige
BDN6668	Earpiece, mic and PTT separate, beige
BDN6669	Earpiece, mic and PTT combined, with extra-loud earphone (exceeds OSHA limits), beige

Accessories

BDN6670	Earpiece, mic and PTT separate with extra-loud earphone (exceeds OSHA limits), beige
BDN6677	Ear mic, standard, noise up to 95 dB (must order BDN6671 interface module), black
BDN6678	Ear mic, standard, noise up to 95 dB (must order BDN6671 interface module), beige
BDN6719	Earpad, with 3.5mm threaded plug
BDN6726	Earpiece with standard earphone, black
BDN6727	Earpiece with extra-loud earphone (exceeds OSHA limits), black
BDN6728	Earpiece with volume control, black
BDN6729	Earpiece, mic and PTT combined, black
BDN6730	Earpiece, mic and PTT separate, black
BDN6731	Earpiece, mic and PTT combined, with extra-loud earphone (exceeds OSHA limits), black
BDN6732	Earpiece, mic and PTT separate, with extra-loud earphone (exceeds OSHA limits), black
BDN6780	Earbud, single with mic and PTT combined, beige
BDN6781	Earbud, single, receive only, black

Headsets and Headset Accessories

BDN6635	Heavy-duty VOX headset with noise-canceling boom mic (requires BDN6673 adapter)
BDN6636	Heavy-duty VOX headset with throat mic (requires BDN6673)
BDN6645	Noise-canceling boom mic headset with PTT on earcup
NMN1020	Safety helmet headset (requires BDN6676 adapter)
NMN6245	Light-weight headset

NMN6246	Ultralite headset with boom mic
NMN6258	Over-the-head headset with in-line PTT
NMN6259	Medium-weight, dual headset with NC mic
RMN4049	Jedi “TEMCO” temple transducer

Radio Interface Modules for Ear Microphones

BDN6671	Push-to-talk (PTT) and voice-activated (VOX) interface module (for use with BDN6641, BDN6677 and BDN6678)
BDN6708	PTT interface module (for use with BDN6641, BDN6677 and BDN6678)

Switches

0180300E83	Remote PTT body switch
NTN7660	Tilt / man down switch

Appendix: Maritime Radio Use in the VHF Frequency Range

Special Channel Assignments

Emergency Channel

If you are in imminent and grave danger at sea and require emergency assistance, use **VHF Channel 16** to send a distress call to nearby vessels and the United States Coast Guard. Transmit the following information, in this order:

- 1 "MAYDAY, MAYDAY, MAYDAY."
- 2 "THIS IS _____, CALL SIGN _____."
State the name of the vessel in distress 3 times, followed by the call sign or other identification of the vessel, stated 3 times.
- 3 Repeat "MAYDAY" and the name of the vessel.
- 4 "WE ARE LOCATED AT _____."
State the position of the vessel in distress, using any information that will help responders to locate you, e.g.:
 - latitude and longitude
 - bearing (state whether you are using true or magnetic north)
 - distance to a well-known landmark
 - vessel course, speed or destination
- 5 State the nature of the distress.
- 6 Specify what kind of assistance you need.
- 7 State the number of persons on board and the number needing medical attention, if any.
- 8 Mention any other information that would be helpful to responders, such as type of vessel, vessel length and/or tonnage, hull color, etc.
- 9 "OVER."
- 10 Wait for a response.
- 11 If you do not receive an immediate response, remain by the radio and repeat the transmission at intervals until you receive a response. Be prepared to follow any instructions given to you.

Non-Commercial Call Channel

For non-commercial transmissions, such as fishing reports, rendezvous arrangements, repair scheduling, or berthing information, use **VHF Channel 9**.

Operating Frequency Requirements

A radio designated for shipboard use must comply with Federal Communications Commission Rule Part 80 as follows:

- on ships subject to Part II of Title III of the Communications Act, the radio must be capable of operating on the 156.800 MHz frequency
- on ships subject to the Safety Convention, the radio must be capable of operating:
 - in the simplex mode on the ship station transmitting frequencies specified in the 156.025 – 157.425 MHz frequency band, and
 - in the semiduplex mode on the two frequency channels specified in the table below.

Note: Simplex channels 3, 21, 23, 61, 64, 81, 82, and 83 **cannot be lawfully used** by the general public in US waters.

Additional information about operating requirements in the Maritime Services can be obtained from the full text of FCC Rule Part 80 and from the US Coast Guard.

Table A-1: VHF Marine Channel List

Channel Number	Frequency (MHz)	
	Transmit	Receive
1	156.050	160.650
2	156.100	160.700
*	156.150	160.750
4	156.200	160.800
5	156.250	160.850
6	156.300	–
7	156.350	160.950

Table A-1: VHF Marine Channel List (Continued)

Channel Number	Frequency (MHz)	
	Transmit	Receive
8	156.400	—
9	156.450	156.450
10	156.500	156.500
11	156.550	156.550
12	156.600	156.600
13**	156.650	156.650
14	156.700	156.700
15**	156.750	156.750
16	156.800	156.800
17**	156.850	156.850
18	156.900	161.500
19	156.950	161.550
20	157.000	161.600
*	157.050	161.650
22	157.100	161.700
*	157.150	161.750
24	157.200	161.800
25	157.250	161.850
26	157.300	161.900
27	157.350	161.950
28	157.400	162.000
60	156.025	160.625
*	156.075	160.675
62	156.125	160.725
63	156.175	160.775
*	156.225	160.825
65	156.275	160.875
66	156.325	160.925

Table A-1: VHF Marine Channel List (Continued)

Channel Number	Frequency (MHz)	
	Transmit	Receive
67**	156.375	156.375
68	156.425	156.425
69	156.475	156.475
71	156.575	156.575
72	156.625	–
73	156.675	156.675
74	156.725	156.725
75	***	***
76	***	***
77**	156.875	–
78	156.925	161.525
79	156.975	161.575
80	157.025	161.625
*	157.075	161.675
*	157.125	161.725
*	157.175	161.775
84	157.225	161.825
85	157.275	161.875
86	157.325	161.925
87	157.375	161.975
88	157.425	162.025

* Simplex channels 3, 21, 23, 61, 64, 81, 82, and 83 **cannot be lawfully used** by the general public in US waters.

** Low power (1 W) only

*** Guard band



Note: A – in the Receive column indicates that the channel is transmit only.

Glossary

This is a list of specialized terms used in this manual.

ACK	Acknowledgment of communication.
Active Channel	A channel that has traffic on it.
Analog Signal	An RF signal that has a continuous nature rather than a pulsed or discrete nature.
ARS	Automatic Registration Service.
ASTRO 25 Trunking	Motorola standard for wireless digital trunked communications.
ASTRO Conventional	Motorola standard for wireless analog or digital conventional communications.
Call Alert	Privately page an individual by sending an audible tone.
Carrier Squelch	Feature that responds to the presence of an RF carrier by opening or unmuting (turning on) a receiver's audio circuit. A squelch circuit silences the radio when no signal is being received so that the user does not have to listen to noise.
Central Controller	A software controlled, computer-driven device that receives and generates data for the trunked radios assigned to it. It monitors and directs the operations of the trunked repeaters.
Channel	A group of characteristics such as transmit/receive frequency pairs, radio parameters, and encryption encoding.
Control Channel	In a trunking system, one of the channels that is used to provide a continuous, two-way/data communications path between the central controller and all radios on the system.

Conventional	Typically refers to radio-to-radio communications, sometimes through a repeater. (See Trunking.)
Cursor	A visual tracking marker (a blinking line) that indicates a location on the display.
Deadlock	Displayed by the radio after three failed attempts to unlock the radio. The radio must be powered off and on prior to another attempt.
Digital Private Line (DPL)	A type of coded squelch using data bursts. Similar to PL except a digital code is used instead of a tone.
Digital Signal	An RF signal that has a pulsed, or discrete nature, rather than a continuous nature.
Dispatcher	An individual who has radio system management duties.
Dynamic Regrouping	A feature that allows the dispatcher to temporarily reassign selected radios to a single special channel so they can communicate with each other.
Failsoft	A feature that allows communications to take place even though the central controller has failed. Each trunked repeater in the system will transmit a data word informing every radio that the system has gone into failsoft.
FCC	Federal Communications Commission.
Hang Up	Disconnect.
Home Display	The first display information after the radio completes its self test.
LCD	Liquid Crystal Display.
LED	Light-emitting diode.

Menu Entry	A software-activated feature shown at the bottom of the display – selection of these features is controlled by the  ,  , and  buttons.
Monitor	Check channel activity by pressing the Monitor button. If the channel is clear, you will hear static. If the channel is in use, you will hear conversation. It also serves as a way to check the volume level of the radio, as the radio will “open the squelch” when pressing the monitor button.
Network Access Code	Network Access Code (NAC) operates on digital channels to reduce voice channel interference between adjacent systems and sites.
NiCd	Nickel Cadmium.
NiMH	Nickel Metal Hydride.
Non-tactical/Revert	The user will talk on a preprogrammed emergency channel. The emergency alarm is sent on this same channel.
Page	A one-way alert, with audio and/or display messages.
Personality	A set of unique features specific to a radio.
PIN	Personal Identification Number.
Preprogrammed	A feature that has been assigned in advance by a qualified technician.
Private (Conversation) Call	Allows you to have a private conversation with another radio user in the group.
Private Line (PL)	A sub-audible tone that is transmitted such that only receivers decoding this tone will hear the message.

Programmable	A radio control that can have a radio feature assigned to it.
PTT	Push-To-Talk – the PTT button engages the transmitter and puts the radio in transmit (send) operation when pressed.
Radio Frequency (RF)	The part of the general frequency spectrum between the audio and infrared light regions (about 10 kHz to 10,000,000 MHz).
Repeater	A conventional radio feature, where you talk through a receive/transmit facility (repeater), that re-transmits received signals in order to improve communications range and coverage.
Selective Switch	Any digital P25 traffic having the correct Network Access Code and the correct talkgroup.
Squelch	Special electronic circuitry added to the receiver of a radio which reduces, or squelches, unwanted signals before they are heard in the speaker.
Standby	An operating condition whereby the radio's speaker is muted but still continues to receive data.
Tactical/Non-revert	The user will talk on the channel that was selected before the radio entered the emergency state.
Talkaround	Bypass a repeater and talk directly to another unit for easy local unit-to-unit communications.
Talkgroup	An organization of radio users who communicate with each other.
TMS	Text Messaging Service.

Glossary

Trunking	The automatic sharing of communications paths between a large number of users. (See Conventional.)
Zone	A grouping of channels.

Commercial Warranty

Limited Warranty

MOTOROLA COMMUNICATION PRODUCTS

I. WHAT THIS WARRANTY COVERS AND FOR HOW LONG:

MOTOROLA INC. (“MOTOROLA”) warrants the MOTOROLA manufactured Communication Products listed below (“Product”) against defects in material and workmanship under normal use and service for a period of time from the date of purchase as scheduled below:

ASTRO XTS 2500 / XTS 2500I Portable Units	One (1) Year
Product Accessories	One (1) Year

Motorola, at its option, will at no charge either repair the Product (with new or reconditioned parts), replace it (with a new or reconditioned Product), or refund the purchase price of the Product during the warranty period provided it is returned in accordance with the terms of this warranty. Replaced parts or boards are warranted for the balance of the original applicable warranty period. All replaced parts of Product shall become the property of MOTOROLA.

This express limited warranty is extended by MOTOROLA to the original end user purchaser only and is not assignable or transferable to any other party. This is the complete warranty for the Product manufactured by MOTOROLA. MOTOROLA assumes no obligations or liability for additions or modifications to this warranty unless made in writing and signed by an officer of MOTOROLA. Unless made in a separate agreement between MOTOROLA and the original end user purchaser, MOTOROLA does not warrant the installation, maintenance or service of the Product.

MOTOROLA cannot be responsible in any way for any ancillary equipment not furnished by MOTOROLA which is attached to or used in connection with the Product, or for operation of the Product with any ancillary equipment, and all such equipment is expressly excluded from this warranty. Because each system which may use

the Product is unique, MOTOROLA disclaims liability for range, coverage, or operation of the system as a whole under this warranty.

II. GENERAL PROVISIONS:

This warranty sets forth the full extent of MOTOROLA'S responsibilities regarding the Product. Repair, replacement or refund of the purchase price, at MOTOROLA's option, is the exclusive remedy. THIS WARRANTY IS GIVEN IN LIEU OF ALL OTHER EXPRESS WARRANTIES. IMPLIED WARRANTIES, INCLUDING WITHOUT LIMITATION, IMPLIED WARRANTIES OF MERCHANTABILITY AND FITNESS FOR A PARTICULAR PURPOSE, ARE LIMITED TO THE DURATION OF THIS LIMITED WARRANTY. IN NO EVENT SHALL MOTOROLA BE LIABLE FOR DAMAGES IN EXCESS OF THE PURCHASE PRICE OF THE PRODUCT, FOR ANY LOSS OF USE, LOSS OF TIME, INCONVENIENCE, COMMERCIAL LOSS, LOST PROFITS OR SAVINGS OR OTHER INCIDENTAL, SPECIAL OR CONSEQUENTIAL DAMAGES ARISING OUT OF THE USE OR INABILITY TO USE SUCH PRODUCT, TO THE FULL EXTENT SUCH MAY BE DISCLAIMED BY LAW.

III. STATE LAW RIGHTS:

SOME STATES DO NOT ALLOW THE EXCLUSION OR LIMITATION OF INCIDENTAL OR CONSEQUENTIAL DAMAGES OR LIMITATION ON HOW LONG AN IMPLIED WARRANTY LASTS, SO THE ABOVE LIMITATION OR EXCLUSIONS MAY NOT APPLY.

This warranty gives specific legal rights, and there may be other rights which may vary from state to state.

IV. HOW TO GET WARRANTY SERVICE:

You must provide proof of purchase (bearing the date of purchase and Product item serial number) in order to receive warranty service and, also, deliver or send the Product item, transportation and insurance prepaid, to an authorized warranty service location. Warranty service will be provided by Motorola through one of its authorized warranty service locations. If you first contact the company

which sold you the Product, it can facilitate your obtaining warranty service. You can also call Motorola at 1-888-567-7347 US/Canada.

V. WHAT THIS WARRANTY DOES NOT COVER:

- A) Defects or damage resulting from use of the Product in other than its normal and customary manner.
- B) Defects or damage from misuse, accident, water, or neglect.
- C) Defects or damage from improper testing, operation, maintenance, installation, alteration, modification, or adjustment.
- D) Breakage or damage to antennas unless caused directly by defects in material workmanship.
- E) A Product subjected to unauthorized Product modifications, disassemblies or repairs (including, without limitation, the addition to the Product of non-Motorola supplied equipment) which adversely affect performance of the Product or interfere with Motorola's normal warranty inspection and testing of the Product to verify any warranty claim.
- F) Product which has had the serial number removed or made illegible.
- G) Rechargeable batteries if:
 - any of the seals on the battery enclosure of cells are broken or show evidence of tampering.
 - the damage or defect is caused by charging or using the battery in equipment or service other than the Product for which it is specified.
- H) Freight costs to the repair depot.
- I) A Product which, due to illegal or unauthorized alteration of the software/firmware in the Product, does not function in accordance with MOTOROLA's published specifications or the FCC type acceptance labeling in effect for the Product at

the time the Product was initially distributed from MOTOROLA.

- J) Scratches or other cosmetic damage to Product surfaces that does not affect the operation of the Product.
- K) Normal and customary wear and tear.

VI. PATENT AND SOFTWARE PROVISIONS:

MOTOROLA will defend, at its own expense, any suit brought against the end user purchaser to the extent that it is based on a claim that the Product or parts infringe a United States patent, and MOTOROLA will pay those costs and damages finally awarded against the end user purchaser in any such suit which are attributable to any such claim, but such defense and payments are conditioned on the following:

- A) that MOTOROLA will be notified promptly in writing by such purchaser of any notice of such claim;
- B) that MOTOROLA will have sole control of the defense of such suit and all negotiations for its settlement or compromise; and
- C) should the Product or parts become, or in MOTOROLA's opinion be likely to become, the subject of a claim of infringement of a United States patent, that such purchaser will permit MOTOROLA, at its option and expense, either to procure for such purchaser the right to continue using the Product or parts or to replace or modify the same so that it becomes non-infringing or to grant such purchaser a credit for the Product or parts as depreciated and accept its return. The depreciation will be an equal amount per year over the lifetime of the Product or parts as established by MOTOROLA.

MOTOROLA will have no liability with respect to any claim of patent infringement which is based upon the combination of the Product or parts furnished hereunder with software, apparatus or devices not furnished by MOTOROLA, nor will MOTOROLA have any liability for

the use of ancillary equipment or software not furnished by MOTOROLA which is attached to or used in connection with the Product. The foregoing states the entire liability of MOTOROLA with respect to infringement of patents by the Product or any parts thereof.

Laws in the United States and other countries preserve for MOTOROLA certain exclusive rights for copyrighted MOTOROLA software such as the exclusive rights to reproduce in copies and distribute copies of such Motorola software. MOTOROLA software may be used in only the Product in which the software was originally embodied and such software in such Product may not be replaced, copied, distributed, modified in any way, or used to produce any derivative thereof. No other use including, without limitation, alteration, modification, reproduction, distribution, or reverse engineering of such MOTOROLA software or exercise of rights in such MOTOROLA software is permitted. No license is granted by implication, estoppel or otherwise under MOTOROLA patent rights or copyrights.

VII. GOVERNING LAW:

This Warranty is governed by the laws of the State of Illinois, USA.

Index

A

- access
 - inbox83
 - sent folder88
 - TMS feature
 - use the menu78
 - use the preprogrammed TMS button79
 - use TMS feature button78
 - user login feature73
- accessories
 - antennas95
 - batteries96
 - belt clips96
 - body-worn96
 - carry accessories96
 - chargers97
 - Commport integrated microphone/receivers99
 - earpieces99
 - headsets100
 - microphones, remote speaker .98
 - radio interface modules101
 - switches101
- alert tones12
- answer a phone call46
- answer a private call50
- antenna
 - attach the antenna18
 - radio operating frequencies93
 - remove the antenna18
- antennas95
- app button4

B

- batteries96
- battery15
 - attach the battery16
 - battery charge status91
 - recycling and disposal92
 - remove the battery16
 - smart battery condition17
- battery charger15

belt clip

- attach the belt clip 19
- remove the belt clip 19

button

- mode select 27

C

- call alert
 - make a call alert 53
- carry accessories
 - belt clips96
 - body-worn96
- change
 - ARS mode 71
- channel
 - select a channel 25
- chargers97
 - enhanced and multi-unit line cords97
- conventional fuel gauge symbol .91
- conventional mode operation 31
- conventional squelch options 34

D

- delete a message 87
- display6
- display status symbols 7
- dynamic priority change 45
- dynamic regrouping 58

E

- edit
 - quick text message86
- emergency36
- emergency keep-alive 40

F

- failsoft61
- four-way navigation button 11

G

- glossary 106

Index

H

home button 11

I

inbox

delete a message 87

view message 83

L

LED indicators 11

list

scan list empty 41

view a list 41

M

make a call alert 53

make a phone call 47

make a private call 51

menu

TMS menu options 80

menu entry (softkey) 9

menu select buttons 9

menu selection features 10

microphones, remote speaker 98

mode

ARS Non server mode 71

ARS server mode 71

mode select button 27

monitor button 30

N

notations used in this manual 1

O

out-of-range 61

P

phone call display and alert

prompts 49

physical features of the radio 4

PL defeat 35

predefined

message,quick text 84

username 74

priority

priority message 81

private call

make a private call 51

private data 77

programmable features 5

PTT ID 56

R

radio care

cleaning 89

handling 89

radio ID number 56

receive a message 83

receive and transmit 28

remote speaker microphone

adapter 21

repeater or direct operation

select repeater or direct 55

reprogram request 58

use the preprogrammed reprogram

request button 59

request a new dynamic regrouping

using the menu 58

S

scan 42

delete a nuisance channel 44

turn scan on and off 42

scan (conventional only)

make a dynamic priority

change 45

scan list empty 41

select

enable / disable 60

select a channel 25

select a zone 23

select channel

preprogrammed channel

selector 25

use the menu entry CHAN 25

use the menu entry CHUP or

CHDN	26	turn the radio on	22
select zone		U	
use the menu entry ZNUP or		universal connector	
ZNDN	24	attach the cover	20
use the menu entry ZONE	23	remove the cover	20
zone switch	24	user	
send		access	
predefined message,quick text		use the menu item	73
message	86	use the preprogrammed user	
send a silent emergency alarm ...	39	button	73
send an emergency alarm	36	log out	77
send an emergency call	37	login	74
service	89	username	
site lock	62	valid characters	74
site trunking	63	V	
change the current site	64	view a list	41
view the current site	63	view message	83
smart battery condition	17	W	
smart fuel gauge symbol	91	warranty	111
squelch		Z	
analog squelch	34	zone	
digital squelch	34	select a zone	23
status		zone switch	24
TMS status symbols	81		
surveillance accessories	99		
Commport integrated microphone/			
receivers	99		
earpieces	99		
headsets and headset accessories			
.....	100		
radio interface modules for ear			
microphones	101		
switches	101		
T			
talkgroup			
select talkgroup	54		
text messaging	78		
time and date	65		
edit time and date	65		
time-out timer	35		
Trunking System Controls	61		
turn the radio off	22		



MOTOROLA

Motorola, Inc.
1301 E. Algonquin Rd.
Schaumburg, IL 60196-1078, U.S.A.

MOTOROLA, the Stylized M Logo, ASTRO
and SmartZone are registered in the
U.S. Patent and Trademark Office.
All other product or service names are the
property of their respective owners.
© 2007, 2008, 2010 by Motorola, Inc.
All rights reserved. Printed in U.S.A.



6816980H01-G